

An ISO 9001:2008 Company

Product Catalogue

ITEC[®]
www.itec.it

F.A.T.I.
Fartak Tajhiz Ista



About Us

ITEC srl., a 100% family owned company, was founded in 1989 in Inverio (NO), Italy. Since from its inception, ITEC has always been focused in manufacturing & sales of mechanical instruments for pressure and temperature measurement. ITEC has been established itself as an European leader in the field of quality and technical expertise. The experience acquired in many years of manufacturing and worldwide sales, enables ITEC srl. with the flexibility to meet customer's needs in terms of short-time inquiry response, expertise to solve and provide the proper measuring instruments and stablest delivery times.

ITEC srl., manufacture and sell Pressure Gauges, Differential Pressure Gauges, Thermometers, Thermowells, Diaphragm Seals, Low Pressure gauges, Valves and Accessories. To serve the customers in a wide other areas of instrumentation, a second unit was started in India, ITEC Measures Pvt. Ltd. This enabled ITEC to expand the existing product line with Pressure Switches, RTDs, Thermocouples, Level Switches, Level Gauges & Flow Switches.

Quality has always been one of the driving synergy of ITEC's working philosophy. ITEC's both manufacturing units are ISO 9001:2008 certified organizations. A certain products are CE marked and as well as ATEX approved.



Facility : ITEC S.r.l.		
Certificate	Certificate number	Certification agency
ISO 9001:2008	IT98/0209	SGS Italia S.p.A.
EC Certificate of Conformity	0068-CPD-016/2013	M. Masini S.r.l.
ATEX	Various	TUV SUD - Italia & IMQ
Facility : ITEC Measures Pvt. Ltd.		
ISO 9001:2008	QM 02 00538	TUV India Pvt. Ltd.
EC Certificate of Conformity	07 202 9070 Z 0067/0/D/001	TUV NORD Systems & Co. KG
IBR approval	DOB/Tech/5594/2014	Indian Boilers Regulations

Under process: ISO 14001:2004 (EMS), OHSAS 18001, GOST, UL...

PRESSURE GAUGES

Full stainless steel type	02
High safety type	03
Heavy duty diaphragm / bellow type	04
Compact / piston type	05
Electric contact / Mechatronic type	06
Diaphragm type	07
Sealed diaphragm type	08
Specialized industries type	09
Utility type	10

TEMPERATURE GAUGES

Inert gas filled type	12
Bi-metallic type	13

DIAPHRAGM SEALS

Threaded type	14
Flanged type	15
Sanitary type	16
Specialized industry type	17

PRESSURE ACCESSORIES

Siphon & Cock	19
Gauge Safety Devices	20
Diaphragm Seal Accessories	21

RTDs

Industrial type	22
Inserts	23
Industry Specific	24

THERMOCOUPLES

Industrial type	25
Inserts	26
Industry Specific	28

THERMOWELLS

Conventional type	30
Customized type	31

LEVEL INSTRUMENTS

Switches : Side / Top mounted type	33
Indicators : Side / Top mounted type	34
Switches : Side / Top mounted type	35

PRESSURE SWITCHES

Utility type	36
Weatherproof type	37
Flameproof / Explosion proof type	38

MANIFOLDS

41

NEEDLE VALVES

42

VALVE ACCESSORIES

43

TUBE FITTINGS

44

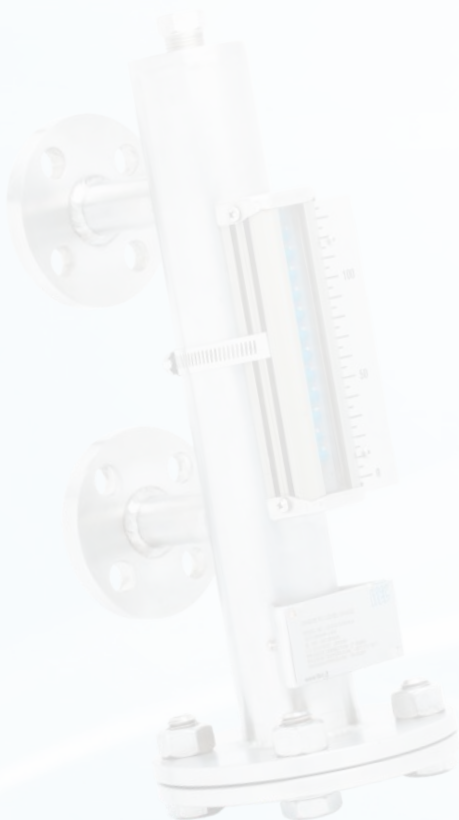
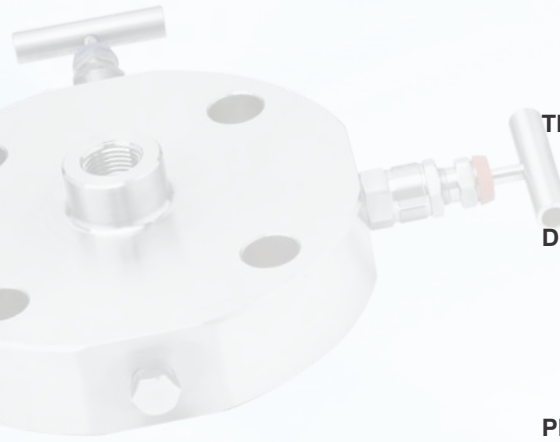

PRESSURE GAUGES

FULL STAINLESS STEEL

APPLICATIONS

- Liquid & gaseous mediums
- Corrosive environments
- Oil & Gas applications
- Chemical & Petrochemical
- Food & Beverages
- Nuclear power plants



BASIC MODEL	P101	P102	P103	P104
SPECIAL FEATURES	All SS measuring system Socket-case, direct welded Dry / liquid filled CE marking	All SS measuring system Socket-case, direct welded Dry / liquid filled CE marking External zero adjustment	All SS measuring system Socket-case, direct welded Dry / liquid filled	All SS measuring system Socket-case, direct welded Dry / liquid filled CE marking DIN style case and ring
NOMINAL DIAL SIZES	DN100, DN125, DN150 & DN250	DN100, DN125, DN150 & DN250	DN50, DN63, DN80 ¹ & DN100 ¹	DN63, DN100 & DN150
RANGE	-1...1,600 bar	-1...1,600 bar	-1...400 bar for DN50 -1...1,000 bar for DN50/80/100	-1...1,600 bar -1...1,000 bar for DN63
ACCURACY	CL 1.0 CL 0.5 or CL 0.6 ²	CL 1.0 CL 0.5 or CL 0.6 ²	CL 1.6	CL 1.0 CL 0.5 or CL 0.6 ²
MOUNTING STYLES	Bottom Bottom with wall mounting Lower back Lower back with 3-hole panel Lower back with mounting bracket 2" Pipe mounting	Bottom Bottom with wall mounting Lower back Lower back with 3-hole panel Lower back with mounting bracket 2" Pipe mounting	Bottom Lower / Centre back Bottom with wall mounting Centre back with 3-hole panel Centre back with mounting bracket	Bottom Lower / Centre back Bottom with wall mounting Centre back with 3-hole panel Centre back with mounting bracket 2" Pipe mounting
PROCESS CONNECTION ³	1/2" NPT (M) 1/2" BSP (M)	1/2" NPT (M) 1/2" BSP (M)	1/4" NPT (M) 1/4" BSP (M)	1/2" NPT (M) 1/2" BSP (M)
WETTED PARTS	AISI 316L SS Monel ²	AISI 316L SS Monel ²	AISI 316L SS	AISI 316L SS Monel ²
CASE MATERIAL	AISI 304 SS AISI 316 SS ² Epoxy coated ²	AISI 304 SS AISI 316 SS ² Epoxy coated ²	AISI 304 SS AISI 316 SS ²	AISI 304 SS AISI 316 SS ² Epoxy coated ²
PROTECTION CLASS	IP 65 (Dry) IP 66 / IP 67 ²	IP 65 (Dry) IP 66 / IP 67 ²	IP 65 (Dry)	IP 65 (Dry) IP 66 / IP 67 ²
REFERENCE STANDARD	EN 837-1	EN 837-1	EN 837-1	EN 837-1
SAFETY CLASS	S1 (Open front, blow off disc)	S1 (Open front, blow off disc)	S1 (Open front) ⁴	S1 (Open front, blow off disc)
WINDOW	Sheet glass Shatterproof / Plexi ²	Sheet glass Shatterproof / Plexi ²	Sheet glass Shatterproof / Plexi ²	Steel glass Shatterproof / Plexi ²
OPTIONAL EXTRAS	NACE MR0175 / MR0103 IBR certificate ATEX certificate Dampened movement MRP Pointer Short overpressure Oxygen service	NACE MR0175 / MR0103 IBR certificate ATEX Certificate Dampened movement MRP Pointer Short overpressure Oxygen service	MRP Pointer Oxygen service ATEX certificate	NACE MR0175 / MR0103 IBR certificate Dampened movement MRP Pointer Short overpressure Oxygen service

Refer pages 14...17 for Diaphragm Seals, 19...21 for Accessories and 39...43 for Valves & Manifolds.

Notes

- In two piece construction (case connected to process connection through sealed compression fitment).
- Optional, charges extra, contact factory for details.
- Other connections & sizes are available, charges extra, contact factory for details.
- For DN80 & DN100 only
- Equivalent scales available in kg/cm², psi, kPa, MPa, bar/psi, kPa/bar, kPa/psi or any other special scales

APPLICATIONS

- Liquid & gaseous mediums
- Corrosive environments
- Oil & Gas applications
- Chemical & Petrochemical
- Food & Beverages



BASIC MODEL	P201	P202	P203	P204
SPECIAL FEATURES	Solid front with full blow back All stainless steel system External zero adjustment ¹	Solid front with full blow back All stainless steel system External zero adjustment	Solid front with full blow back All stainless steel system Dry / Filled version	Solid Front, Turret design Thermoplastic case Standard accuracy $\pm 0.5\%$ FS
NOMINAL DIAL SIZES	DN100 & DN150	DN100 & DN150	DN63	4.5"
RANGE	-1...1,600 bar	-1...1,600 bar	-1...1,000 bar	-1...1,600 bar
ACCURACY	CL 1.0 CL 0.5 or CL 0.6 ¹	CL 1.0 CL 0.5 or CL 0.6 ¹	CL 1.6	CL 0.5 CL 1.0 ¹
MOUNTING STYLES	Bottom Bottom with wall mounting Lower back with 3-hole panel	Bottom Bottom with wall mounting Lower back with 3-hole panel	Bottom Bottom with wall mounting Centre back with 3-hole panel	Bottom Bottom with wall mounting Lower back with 3-hole panel
PROCESS CONNECTION ²	1/2" NPT (M) 1/2" BSP (M)	1/2" NPT (M) 1/2" BSP (M)	1/4" NPT (M) 1/4" BSP (M)	1/2" NPT (M) 1/4" NPT (M)
WETTED PARTS	AISI 316L SS Monel ¹	AISI 316L SS Monel ¹	AISI 316L SS	AISI 316L SS Monel ¹
CASE MATERIAL	AISI 304 SS AISI 316 SS ¹	AISI 304 SS AISI 316 SS ¹	AISI 304 SS AISI 316 SS ¹	Phenolic Resin (PBTP)
PROTECTION CLASS	IP 65 (Dry) IP 66 / IP 67 ¹	IP 65 (Dry) IP 66 / IP 67 ¹	IP 65 (Dry)	IP 65 (Dry) IP 66 / IP 67 ¹
REFERENCE STANDARD	EN 837 - 1	EN 837 - 1	EN 837 - 1	ANSI B 40.1
SAFETY CLASS	S3 (Solid front, full blow back)	S3 (Solid front, full blow back)	S3 (Solid front, full blow back)	Solid front, full blow back
WINDOW	Shatterproof	Shatterproof	Shatterproof	Sheet glass Shatterproof / Plexi ¹
OPTIONAL EXTRAS	NACE MR0175 / MR0103 IBR certificate ATEX certificate Dampened movement MRP Pointer Short overpressure Oxygen service	NACE MR0175 / MR0103 IBR certificate ATEX certificate Dampened movement MRP Pointer Short overpressure Oxygen service	MRP Pointer Oxygen service	NACE MR0175 / MR0103 IBR certificate Dampened movement Short overpressure Oxygen service

Refer pages 14...17 for Diaphragm Seals, 19...21 for Accessories and 39...43 for Valves & Manifolds.

- Notes**
1. Optional, charges extra, contact factory for details.
 2. Other connections & sizes are available, charges extra, contact factory for details.
 3. Equivalent scales available in kg/cm², psi, kPa, MPa, bar/psi, kPa/bar, kPa/psi or any other special scales.

DIFFERENTIAL PRESSURE GAUGES

HEAVY DUTY DIAPHRAGM / BELLOWS

APPLICATIONS

- Liquid & gaseous mediums
- Corrosive environments
- Oil & Gas applications
- Chemical & Petrochemical
- Filtration & Water applications
- Pumps, compressors & diesel engines



BASIC MODEL	P301	P302	P303	P303
SPECIAL FEATURES	Single side static sustainable Electric contacts (Optional) Static pressure 400 bar (max) Dry / liquid filled ATEX certificate External Zero Adjustment	Single side static sustainable All SS measuring system Electric contacts (Optional) Static pressure 100 bar (max) Dry / liquid filled External Zero Adjustment	Economical version All SS measuring system Static pressure 4 bar (max) Bellow type Electric contacts (Optional) External Zero Adjustment	Suitable for direct valve mounting All SS measuring system Static pressure 4 bar (max) Bellow type Electric contacts (Optional) External Zero Adjustment
NOMINAL DIAL SIZES	DN100, DN125 & DN150	DN100, DN125 & DN150	DN150	DN150
RANGE	400mmWC...60 bar	0.6...10 bar	100 mbar...6 bar	100 mbar...6 bar
ACCURACY	CL 1.6 CL 1.0 ¹	CL 2.5	CL 1.6 (range ≤ 1 bar) CL 1.0 (range > 1 bar)	CL 1.6 (range ≤ 1 bar) CL 1.0 (range > 1 bar)
MOUNTING STYLES	Bottom Bottom with wall mounting Bottom with 2" Pipe / Yoke Centre back with 3-hole panel	Bottom Bottom with wall mounting Bottom with 2" Pipe / Yoke Centre back with 3-hole panel	Bottom Bottom with wall mounting Bottom with 2" Pipe / Yoke	Bottom Bottom with wall mounting Bottom with 2" Pipe / Yoke
PROCESS CONNECTION ²	1/4" NPT (F) x 2 Nos	1/4" NPT (F) x 2 Nos	1/2" NPT (M) x 2 Nos	1/2" NPT (M) x 2 Nos
CHAMBERS	AISI 316L SS Monel ² Hastelloy C ²	AISI 304 SS AISI 316L SS ²	AISI 316L SS	AISI 316L SS
DIAPHRAGM	AISI 316L SS Monel ² Hastelloy C ²	AISI 316L SS	AISI 316L SS	AISI 316L SS
CASE MATERIAL	AISI 304 SS AISI 316 SS (Optional)	AISI 304 SS AISI 316 SS (Optional)	AISI 304 SS AISI 316 SS (Optional)	AISI 304 SS AISI 316 SS (Optional)
PROTECTION CLASS	IP 67	IP 65 (Dry)	IP 65 (Dry)	IP 65 (Dry)
STATIC PRESSURE	40 bar for 400...600 mmWC 100 bar for ≥1000 mmWC	40 bar standard 100 bar (Optional)	6 bar up to 0.4 bar 25 bar for 1 bar...2.5 bar 40 bar for 4 bar...16 bar	6 bar up to 0.4 bar 25 bar for 1 bar...2.5 bar 40 bar for 4 bar...16 bar
WINDOW	Shatterproof	Shatterproof, Sheet glass	Shatterproof	Shatterproof
REFERENCE STANDARD	EN 837 - 3	EN 837 - 3	EN 837 - 3	EN 837 - 3
OPTIONAL EXTRAS	NACE MR0175 / MR0103 MRP Pointer Oxygen service Static pressure 250 bar Static pressure 400 bar	MRP Pointer Dampened movement Oxygen service CE / ATEX approved contacts Single / Double insulated contacts Inductive type contacts	MRP Pointer	MRP Pointer

Refer pages 14...17 for Diaphragm Seals, 19...21 for Accessories and 39...43 for Valves & Manifolds.

- Notes**
1. Optional, charges extra, contact factory for details.
 2. Other connections & sizes are available, charges extra, contact factory for details.
 3. Equivalent scales available in kg/cm², psi, kPa, MPa, bar/psi, kPa/bar, kPa/psi or any other special scales.

DIFFERENTIAL PRESSURE GAUGES

COMPACT / PISTON

APPLICATIONS

- Hydraulic & pneumatic
- Pumps & compressors
- Diesel engines
- Water applications
- Filtration plants
- Blower vacuum monitoring
- Duct or room pressures
- Clean room applications



	P401	P402	P403	P404
BASIC MODEL	P401	P402	P403	P404
SPECIAL FEATURES	Compact design Migrated pressure chamber Static pressure 200 bar (max) Piston operated	Isolated pressure chamber Static pressure 100 bar (max) Diaphragm operated	Isolated pressure chamber Static pressure 100 bar (max) Ex-proof version Various types of switches	Die cast aluminum case Silicon rubber diaphragm Jeweled bearings Red tipped pointer
NOMINAL DIAL SIZES	DN63, DN100 & DN150	DN63, DN100 & DN150	DN63, DN100 & DN150	120 mm
RANGE	0.25...10 bar	25 mmWC...600 mmWC (LP) 0.075...4 bar (HP)	25 mmWC...600 mmWC (LP) 0.075...4 bar (HP)	-20 "Hg...15 psig -0.677...1.034 bar
ACCURACY (Assending)	CL 4.5 CL 2.0	CL 2.0	CL 2.0	CL 2.0
MOUNTING STYLES	Bottom/with 3-hole panel Back/with 3-hole panel In-line/with 3-hole panel	Bottom/with 3-hole panel Back/with 3-hole panel In-line/with 3-hole panel	Bottom/with 3-hole panel Back/with 3-hole panel In-line/with 3-hole panel	Back / Panel
PROCESS CONNECTION¹	1/4" NPT (F) x 2 Nos	1/4" NPT (F) x 2 Nos	1/4" NPT (F) x 2 Nos	1/8" NPT (F) x 2 Nos
WETTED PARTS	AISI 316 SS Aluminum ²	AISI 316 SS Aluminum ²	AISI 316 SS Aluminum ²	Consult factory
CASE MATERIAL	AISI 304 SS	AISI 304 SS	AISI 304 SS	Die cast aluminum
PROTECTION CLASS	IP 65 (Dry)	IP 65 (Dry)	IP 65 (Dry)	-
STATIC PRESSURE	200 bar	100 bar for HP 35 bar for LP	100 bar for HP 35 bar for LP	25 psig (1.72 barg)
WINDOW	Sheet glass Shatterproof / Plexi ²	Sheet glass Shatterproof / Plexi ²	Sheet glass Shatterproof / Plexi ²	Acrylic
OPTIONAL EXTRAS	MRP Pointer Reed switches	MRP Pointer Reed switches	MRP Pointer Reed switches	-

Refer pages 14...17 for Diaphragm Seals, 19...21 for Accessories and 39...43 for Valves & Manifolds.

- Notes**
1. Other connections & sizes are available, charges extra, contact factory for details.
 2. Optional, charges extra, contact factory for details.
 3. Equivalent scales available in kg/cm², psi, kPa, MPa, bar/psi, kPa/bar, kPa/psi or any other special scales.

APPLICATIONS

- Pumps & motor controls
- Water treatment plants
- Hydraulic & pneumatics
- Chemical & petrochemicals
- Pharmaceutical industries
- HVAC & compressor industries
- Refrigeration



BASIC MODEL	P501	P502	P503	P504
SPECIAL FEATURES	Electrical contacts Dome type case Filled version optional	Electrical contacts High Case version Filled version optional	Analogue gauge with transmitter Solid front with full blow back Transmitter output (4...20 mA)	CE complied microswitch SS case & measuring system High repeatability
NOMINAL DIAL SIZES	DN100 & DN150	DN100 & DN150	DN100 & DN150	DN100 & DN150
RANGE	-1...1,600 bar	-1...1,600 bar	-1...600 bar	-1...600 bar
ACCURACY	CL 1.0 ⁴	CL 1.0 ⁴	CL 1.0 ⁵	CL 1.0 ⁵
MOUNTING STYLES	Bottom Lower back Bottom with wall mounting Lower back with 3-hole panel Lower back with mounting bracket	Bottom Lower back Bottom with wall mounting Lower back with 3-hole panel	Bottom Bottom with wall mounting	Bottom
PROCESS CONNECTION ¹	1/2" NPT (M) 1/2" BSP (M)	1/2" NPT (M) 1/2" BSP (M)	1/2" NPT (M) 1/2" BSP (M)	1/2" NPT (M) 1/2" BSP (M)
WETTED PARTS	AISI 316L SS Monel ²	AISI 316L SS Monel ²	AISI 316L SS	AISI 316L SS Monel ²
CASE MATERIAL	AISI 304 SS AISI 316 SS ²	AISI 304 SS AISI 316 SS ²	AISI 304 SS	AISI 304 SS
PROTECTION CLASS	IP 65 (Dry)	IP 65 (Dry)	IP 65 (Dry)	IP 65 (Dry)
REFERENCE STANDARD	EN 837 - 1	EN 837 - 1	EN 837 - 1	EN 837 - 1
SAFETY CLASS	S1 (Open front, blow off disc)	S1 (Open front, blow off disc)	S3 (Solid front, full blow back)	S1 (Open front, blow off disc)
WINDOW	Plexi	Shatterproof Plexi ²	Shatterproof Plexi ²	Plexi
OPTIONAL EXTRAS	CE / ATEX approved contacts Single / Double insulated contacts Inductive type contacts SPDT / DPDT Booster relay for Inductive contacts Dampened movement Dielectric oil filled	CE / ATEX approved contacts Single / Double insulated contacts Inductive type contacts SPDT / DPDT Booster relay for Inductive contacts Dampened movement Dielectric oil filled	Dampened movement	1 SPDT / 2 SPDT

Refer pages 14...17 for Diaphragm Seals, 19...21 for Accessories and 39...43 for Valves & Manifolds.

- Notes**
1. Other connections & sizes are available, charges extra, contact factory for details.
 2. Optional, charges extra, contact factory for details.
 3. Equivalent scales available in kg/cm², psi, kPa, MPa, bar/psi, kPa/bar, kPa/psi or any other special scales.





4 Gauge accuracy CL 1.0 & Switching accuracy within CL 5.0

5. Gauge accuracy CL 1.0 & Switching accuracy as per the Microswitch® / Transmitter

APPLICATIONS

- Low viscous liquids
- LP draft measurement
- Non-crystallized media
- Non-corrosive environments
- Clean-air, pharmaceutical & breweries



				
BASIC MODEL	P601	P602	P604	P603
SPECIAL FEATURES	All SS measuring system Socket-case direct welded Zero adjustment, on dial Dry / filled version	All SS measuring system Threaded/Flanged connections External Zero adjustment ⁷	All stainless steel system Electric contacts (Optional) Screwed/Flanged connections	Compact design Stainless steel case Zero adjustment, on dial
NOMINAL DIAL SIZES	DN63, DN100, DN125 & DN150	DN100 & DN150	DN100 & DN150	DN63, DN100 & DN150
RANGE	-600...25...600 mbar 6...16 mbar ⁷ 100...600 mbar ⁶	-1...0...25 bar ⁴ 60...600 mbar 6...40 mbar	-1...0.4...40 bar	-600...25...600 mbar
ACCURACY	CL 1.6...CL 2.5	CL 1.6 CL 2.5 (below 60 mbar)	CL 1.6	CL 2.5
MOUNTING STYLES	Bottom Bottom with wall mounting Lower (LB) / Centre (CB) back LB ⁵ / CB with 3-hole panel LB ⁵ / CB with mounting bracket	Bottom Bottom with 2" Pipe / Yoke	Bottom Bottom with 2" Pipe / Yoke	Bottom Bottom with wall mounting Lower / Centre back Centre back with 3-hole panel Centre back with mounting bracket
PROCESS CONNECTION ¹	1/2" NPT (M) / BSP (M) [DN100/125/150] 1/4" NPT (M) [DN63]	1/2" NPT (M) 1/2" BSP (M)	1/2" NPT (M) 1/2" BSP (M)	1/2" BSP (M) [DN100/150] 1/4" BSP (M) [DN63]
WETTED PARTS	AISI 316 SS	AISI 316 SS ⁴	AISI 316 SS	Copper Alloy
CASE MATERIAL	AISI 304 SS AISI 316 SS ²	AISI 304 SS AISI 316 SS ²	AISI 304 SS AISI 316 SS ²	AISI 304 SS
PROTECTION CLASS	IP 65 (Dry) IP 66 / IP 67 ²	IP 65 (Dry) IP 66 / IP 67 ²	IP 65 (Dry) IP 66 / IP 67 ²	IP 54
REFERENCE STANDARD	EN 837 - 3	EN 837 - 3	EN 837 - 3	EN 837 - 3
SAFETY CLASS	S1 (Open front)	S1 (Open Front)	S1 (Open Front)	S1 (Open Front)
WINDOW	Sheet glass Shatterproof / Plexi ²	Sheet glass Shatterproof / Plexi ²	Sheet glass Shatterproof / Plexi ²	Sheet glass Shatterproof / Plexi ²
OPTIONAL EXTRAS	Filled version External zero adjustment Dampening screw Phenol case version ON/OFF type vent plug	PTFE protection on wetted parts Oxygen service	Filled version External zero adjustment Monel / Hastelloy C diaphragms PTFE protection on wetted parts Oxygen service Electric contact versions Special overpressure protection	

Refer pages 14...17 for Diaphragm Seals, 19...21 for Accessories and 39...43 for Valves & Manifolds.

Notes

- Other connections & sizes are available, charges extra, contact factory for details.
- Optional, charges extra, contact factory for details.
- Equivalent scales available in kg/cm², psi, kPa, MPa, bar/psi, kPa/bar, kPa/psi or any other special scales.
- Diaphragm material Spring steel + PTFE -1~10 bar
- Not available in DN63 sizes.
- Applicable in filled version.
- Only available in DN150.

APPLICATIONS

- Sterile applications
- Oil & Gas applications
- Corrosive environments
- Dairy, Ice cream industries
- Sanitary, food & beverages
- Pharmaceutical & paint industries
- Prevent Bacterial & fungal accumulation



BASIC MODEL	P701	P702	P703	P704
SPECIAL FEATURES	Integrated gauge seal assembly Laser welded diaphragm Reduced vibration/pulsation	Laser welded diaphragm Electric contacts ² Transmitter output ² Filled version	All welded system Diaphragm seal integrally welded to the gauge	All welded system Diaphragm seal integrally welded to the gauge
NOMINAL DIAL SIZES	DN50, DN63, DN80 ⁴ & DN100 ⁴	DN100	DN100 ⁴ & DN150 ⁴	DN100, DN125 & DN150
RANGE	-1...40 bar	0...160 bar / 0...250 bar / 0...400 bar / 0...600 bar	4...70 bar	-1...400 bar
ACCURACY	CL 1.6	CL 1.6	CL 1.6	CL 1.6
MOUNTING STYLES	Bottom	Bottom	Bottom	Bottom
PROCESS CONNECTION ¹	Centre back 1.5" Clamp	Homogenizer, connection Homogenizer, with flange Homogenizer, with 1/4" BSP (F)	1/2" NPT (M) 1/2" BSP (M)	Lower back 1"...5" flange, ANSI B16.5 Rating: 150#...2500#
WETTED PARTS (Diaphragm & bottom chamber)	AISI 316L SS	AISI 316L SS	AISI 316 SS	AISI 316L SS ²
CASE MATERIAL	AISI 304 SS AISI 316 SS ²	AISI 304 SS AISI 316 SS ²	AISI 304 SS AISI 316 SS ²	AISI 304 SS AISI 316 SS ²
PROTECTION CLASS	IP 65 (Dry) IP 66 / IP 67 ²	IP 65 (Dry) IP 66 / IP 67 ²	IP 65 (Dry) IP 66 / IP 67 ²	IP 65 (Dry) IP 66 / IP 67 ²
REFERENCE STANDARD	EN 837-1	EN 837-1	EN 837-1	EN 837-1
SAFETY CLASS	S1 (Open Front)	S1 (Open front, blow off disc)	S1 (Open front, blow off disc)	S1 (Open front, blow off disc)
WINDOW	Shatterproof	Shatterproof	Shatterproof	Shatterproof
OPTIONAL EXTRAS	Filled version Tri clamp with gasket Bottom mating part	MRP pointer Magnetic contacts	Filled version Oxygen service	Filled version Oxygen service Dampened movement MRP pointer External zero adjustment

Refer pages 14...17 for Diaphragm Seals, 19...21 for Accessories and 39...43 for Valves & Manifolds.

- Notes**
1. Other connections & sizes are available, charges extra, contact factory for details.
 2. Optional, charges extra, contact factory for details.
 3. Equivalent scales available in kg/cm², psi, kPa, MPa, bar/psi, kPa/bar, kPa/psi or any other special scales.
 4. DN63 measuring system

APPLICATIONS

- Calibration & testing labs
- Mud pumps & Well drilling
- Oil & Gas applications
- Petroleum industries
- Nuclear power plants
- Furnace or flow measurement
- Steam boilers & thermal power stations



BASIC MODEL	P801	P802	P803	P804
SPECIAL FEATURES	Precision measuring system High resolution dial Anti-parallax mirror band Jewel bearing movement	Socket-case, direct welded CE marking External zero adjustment External deadband adjustment	Rugged construction Fixed pointer, moving dial	Economical version
NOMINAL DIAL SIZES	DN150 & DN250	DN150	DN100	150x78 mm OR 200x104 mm
RANGE	-1...700 bar	-1...1,600 bar	0...40 bar up to 0...800 bar	-600...600 mbar
ACCURACY	CL 0.25	CL 1.0	CL 2.0	CL 2.5
MOUNTING STYLES	Bottom Bottom with wall mounting Lower back Lower back with 3-hole panel Lower back with mounting bracket	Bottom Lower back	Bottom	Back with wall mounting
PROCESS CONNECTION ¹	1/2" NPT (M) 1/2" BSP (M)	1/2" NPT (M) 1/2" BSP (M)	2" NPT (M) 2" BSP (M)	1/4" BSP (M)
WETTED PARTS	Beryllium copper and AISI 316L SS	AISI 316L SS Monel ²	AISI 316 SS	Copper Alloy and AISI 304 SS
CASE MATERIAL	AISI 304 SS AISI 316 SS ²	AISI 304 SS AISI 316 SS ²	Gun metal	Steel, black painted
PROTECTION CLASS	IP 65 (Dry)	IP 65 (Dry) IP 66 / IP 67 ²	IP 65 (Dry)	-
REFERENCE STANDARD	EN 837-1	EN 837-1	-	-
SAFETY CLASS	S1 (Open front, blow off disc)	S1 (Open front, blow off disc)	-	-
WINDOW	Shatterproof	Shatterproof	Plexi	Plexi
OPTIONAL EXTRAS	Solid Front case NPL / NABL traceability Wooden carrying case Calibration tool kit	NACE MR0175 / MR0103 Filled version Customized deadband dials	SS tag plate	SS tag plate



Triple scale available



Pinewood box

Refer pages 14...17 for Diaphragm Seals, 19...21 for Accessories and 39...43 for Valves & Manifolds.

- Notes**
1. Other connections & sizes are available, charges extra, contact factory for details.
 2. Optional, charges extra, contact factory for details.
 3. Equivalent scales available in kg/cm², psi, kPa, MPa, bar/psi, kPa/bar, kPa/psi or any other special scales.

APPLICATIONS

- Valve positioners
- HVAC & FLR Units
- Water & air applications
- Allied process industries
- Tyre pressure measurement
- Air conditioning & Refrigeration
- Pumps, compressors & diesel engines



BASIC MODEL	P901	P902	P904	P903
SPECIAL FEATURES	Economical version General purpose application Copper alloy system	Stainless steel case Dry / liquid filled Copper alloy system	Compact design	Ammonia application Coated MS case Dial with refrigerant scales
NOMINAL DIAL SIZES	DN25, DN40, DN50, DN63 DN80, DN100, DN150 & DN250	DN50, DN63, DN80 & DN100	DN50 & DN63	DN100
RANGE	-1...10 bar for DN25 & DN40 -1...400 bar for others	-1...280 bar for DN50 -1...400 bar for DN63/80/100	0...30 psi, 0...60 psi, 0...100 psi, 0...150 psi & 0...220 psi	-1...12.5 kg/cm ² /psi -1...16 kg/cm ² /psi -1...25 kg/cm ² /psi
ACCURACY	CL 2.5 for DN25/40/50 CL 1.6 for others	CL 2.5 for DN50 CL 1.6 for others	CL 1.6 for DN63 CL 2.5 for DN50	CL 1.6
MOUNTING STYLES	Bottom Centre back Bottom with wall mounting Centre back with 3-hole panel Centre back with mounting bracket	Bottom Centre back Bottom with wall mounting Centre back with 3-hole panel Centre back with mounting bracket	Bottom	Bottom Bottom with wall mounting
PROCESS CONNECTION 1	1/8" BSP (M)...1/2" BSP (M) 1/8" NPT (M)...1/2" NPT (M)	1/4" NPT (M) 1/4" BSP (M)	Twin connection	1/4" NPT (M) 3/8" NPT (M)
WETTED PARTS	Copper Alloy	Copper Alloy	Copper Alloy	AISI 316 SS + AISI 304 SS
CASE MATERIAL	Steel, black painted	AISI 304 SS AISI 316 SS ²	AISI 304	Steel, black painted
PROTECTION CLASS	IP 32	IP 65 (Dry)	IP 55 (Dry)	-
REFERENCE STANDARD	EN 837 - 1	EN 837 - 1	-	EN 837-1
SAFETY CLASS	-	S1 (Open Front) ⁴	-	-
WINDOW	Sheet glass	Plexi	Sheet glass	Sheet glass
OPTIONAL EXTRAS	Oxygen service Dampening screw Customized dials as per OEM SS tag plate	Oxygen service Dampening screw Customized dials as per OEM SS tag plate	Customized dials as per OEM	Customized dials as per OEM SS tag plate

Refer pages 14...17 for Diaphragm Seals, 19...21 for Accessories and 39...43 for Valves & Manifolds.

- Notes**
1. Other connections & sizes are available, charges extra, contact factory for details.
 2. Optional, charges extra, contact factory for details.
 3. Equivalent scales available in kg/cm², psi, kPa, MPa, bar/psi, kPa/bar, kPa/psi or any other special scales.
 4. For DN80 & DN100 only.

THERMOMETER GUIDANCE

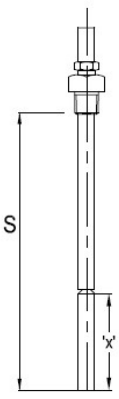
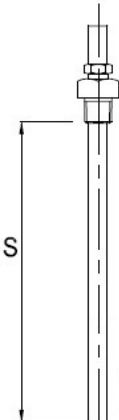
Manufactured Temperature Ranges		Sensor Length Chart for Inert Gas Thermometer		
		Stem / Sensor Size (mm)	(x) Sensor Length (mm)	(S) Minimum Stem Length (mm)
-20...+40		Rigid Stem type Inert Gas Thermometer		
-20...+60		Capillary type Inert Gas Thermometer (≤10 Mtr.)		
-20...+80		6 / 6.35	200	240
-20...+100		8 / 9.5	120	160
-20...+120		10	90	130
-20...+180		12 / 14	70	110
-30...+50		Capillary type Inert Gas Thermometer (>10 Mtr. up to 25 Mtr.)		
-30...+70		8 / 9.5	170	210
-40...+40		10	140	180
-40...+60		12 / 14	90	130
-50...+100		Capillary compensation is preferred for all capillary inert gas thermometers, whose capillary length is above 6 meter.		
-100...+60				
0...50				
0...60				
0...80				
0...100				
0...120				
0...150				
0...160				
0...200				
0...250				
0...300				
0...400				
0...500				
0...600				
0...650				
50...650				
100...600				
100...700				

ELECTRIC CONTACT DETAILS (FOR PRESSURE / TEMPERATURE GAUGE SWITCHES)			
Switch type	Contacts	Action	Rating
Normally closed (1NC)	Single	Break contact	230VAC/1A; 48VDC/0.5A
Normally open (1NO)	Single	Make contact	230VAC/1A; 48VDC/0.5A
Normally closed (2NC)	Double	Break contact	230VAC/1A; 48VDC/0.5A
Normally open (2NO)	Double	Make contact	230VAC/1A; 48VDC/0.5A
Normally closed + Normally open (1NC+1NO)	Double	Break contact + Make contact	230VAC/1A; 48VDC/0.5A
Normally open + Normally closed (1NO+1NC)	Double	Make contact + Brake contact	230VAC/1A; 48VDC/0.5A
SPDT	Single		230VAC/1A; 48VDC/0.5A
DPDT	Double		230VAC/1A; 48VDC/0.5A
Normally closed (1NC)	Single	Break contact	220VAC/0.4A
Normally open (1NO)	Single	Make contact	220VAC/0.4A
Normally closed (2NC)	Double	Break contact	220VAC/0.4A
Normally open (2NO)	Double	Make contact	220VAC/0.4A
Normally closed + Normally open (1NC+1NO)	Double	Break contact + Make contact	220VAC/0.4A
Normally open + Normally closed (1NO+1NC)	Double	Make contact + Brake contact	220VAC/0.4A

MICROSWITCH DETAILS (FOR PRESSURE / TEMPERATURE SWITCHES)		
Microswitch protection	Type	Switch rating
General; low deadband	1 SPDT	250VAC/15A; 24VDC/2A or 110VDC/0.4A or 220VDC/0.2A
General; high deadband	1 SPDT	250VAC/15A; 24VDC/6A or 110VDC/0.5A or 220VDC/0.25A
Adjustable differential	1 SPDT	250VAC/15A
Gold plated contact	1 SPDT	125VAC/1A; 28VDC/0.5A
Environmentally sealed silver contact	1 SPDT	250VAC/15A; 125VDC/0.4A
Environmentally sealed gold contact	1 SPDT	28VDC/1A
Hermetically sealed silver contact	1 SPDT	230VAC/4A; 28VDC/3A resistive; 24VDC/2A inductive
Hermetically sealed gold contact	1 SPDT	125VAC/1A
High DC rating	1 SPDT	125VAC/10A; 125VDC/10A resistive; 125VDC/6A inductive
DPDT	1 DPDT	125VAC/10A; 250VDC/0.2A resistive

APPLICATIONS

- Liquid & gaseous mediums
- Corrosive environments
- Oil & Gas applications
- Chemical & Petrochemical



BASIC MODEL	T701	T702	T703	T707
SPECIAL FEATURES	Inert gas filled expansion External Zero adjustment Capillary compensation ¹ Bi-metal compensation	Inert gas filled expansion Filled versions Capillary compensation ¹ Bi-metal compensation	Inert gas filled expansion Electric contacts Capillary compensation ¹ Bi-metal compensation	Inert gas filled expansion Anti-vibration spring assembly
NOMINAL DIAL SIZES	DN100, DN125, DN150 & DN250	DN100, DN125, DN150 & DN250	DN100, DN125, DN150 & DN250	DN100 & DN150
RANGE	-100...650°C ³	-100...650°C ³	-100...650°C ³	-100...650°C ³
STEM LENGTH (BELOW THREAD)	110...600 mm ≥ 600...2000 mm ¹	110...600 mm ≥ 600...2000 mm ¹	110...600 mm ≥ 600...2000 mm ¹	110...600 mm
SHEATH DIAMETER	8 mm 6 mm / 6.35 mm (1/4") 9.5 mm / 10 mm / 12 mm	8 mm 6 mm / 6.35 mm (1/4") 9.5 mm / 10 mm / 12 mm	8 mm 6 mm / 6.35 mm (1/4") 9.5 mm / 10 mm / 12 mm	12 mm
ACCURACY	CL 1.0	CL 1.0	CL 1.0	CL 1.0
MOUNTING STYLES	Bottom Lower back / Centre back Bottom with wall mounting Lower back with 3-hole panel Lower back with mounting bracket	Bottom Lower back / Centre back Bottom with wall mounting Lower back with 3-hole panel Lower back with mounting bracket Every angle entry clamp entry	Bottom Lower back / Centre back Bottom with wall mounting Lower back with 3-hole panel Lower back with mounting bracket Every angle entry clamp entry	Bottom
PROCESS CONNECTION ²	1/2" NPT (M) 1/2" BSP (M) (Fixed / Adjustable / Swivel)	1/2" NPT (M) 1/2" BSP (M) (Fixed / Adjustable / Swivel)	1/2" NPT (M) 1/2" BSP (M) (Fixed / Adjustable / Swivel)	1/2" NPT (M) 1/2" BSP (M) (Fixed / Adjustable / Swivel)
CASE / ENCLOSURE MATERIAL	AISI 304 SS AISI 316 SS ¹	AISI 304 SS AISI 316 SS ¹	AISI 304 SS AISI 316 SS ¹	AISI 304 SS AISI 316 SS ¹
CAPILLARY ARMOUR	AISI 304 SS / AISI 316 SS AISI 304 SS / AISI 316 SS / PVC (Max length 25 mtrs.)	AISI 304 SS / AISI 316 SS AISI 304 SS / AISI 316 SS / PVC (Max length 25 mtrs.)	AISI 304 SS / AISI 316 SS AISI 304 SS / AISI 316 SS / PVC (Max length 10 mtrs.)	
PROTECTION CLASS	IP 65 IP 66 / IP 67 ¹ EN 13190	IP 65 IP 66 / IP 67 ¹ EN 13190	IP 65 IP 66 / IP 67 ¹ EN 13190	IP 65 IP 66 / IP 67 ¹ EN 13190
REFERENCE STANDARD	Silicon / Glycerin filled	Silicon / Glycerin filled	Dielectric oil filled	Helium gas filled system
OPTIONAL EXTRAS	MRP pointer Dampened movement Helium gas filled system	MRP pointer Dampened movement Helium gas filled system	High-case version Helium gas filled system Magnetic / Inductive contacts CE / ATEX approved contacts	

Refer pages 30...32 for Thermowells.

Notes

1. Optional, charges extra, contact factory for details.
2. Other connections, sizes & types (threaded / flanged / triclamp) are available, charges extra, contact factory for details.
3. Refer "Thermometer guidance" for available ranges & knowing minimum stem/sensor lengths. Equivalent scales available in °F, °C/°F, °F/°C.
4. Refer "Thermometer guidance" page for further details on the switch ratings.
5. Gauge accuracy CL 1.0 & switching accuracy within CL 5.0

APPLICATIONS

- Liquid & gaseous mediums
- Corrosive environments
- Oil & Gas applications
- Chemical & Petrochemical
- Food & Beverages
- Nuclear power plants



BASIC MODEL	T501	T502	T503	T706
SPECIAL FEATURES	Bimetal helix system Hermetically sealed Stem length max up to 1.5 Mtr	Bimetal helix system Hermetically sealed Every angle entry External zero adjustment	Bimetal helix system Hermetically sealed Elbow mounting External zero adjustment	Exhaust temperature application Resistant to vibration issues Nitrogen filled system Silicon oil dampened
NOMINAL DIAL SIZES	DN50, DN63, DN80, DN100, DN125 & DN150	DN80, DN100, DN125 & DN150	DN100, DN125 & DN150	DN100
RANGE	-100...650°C ³	-100...650°C ³	-100...650°C ³	+50...+650°C/°F
STEM LENGTH	50...600 mm	50...600 mm	50...600 mm	200 mm, 250 mm & 300 mm
SHEATH DIAMETER	8 mm 6 mm / 6.35 mm (1/4") 9.5 mm / 10 mm / 12 mm	8 mm 6 mm / 6.35 mm (1/4") 9.5 mm / 10 mm / 12 mm	8 mm 6 mm / 6.35 mm (1/4") 9.5 mm / 10 mm / 12 mm	12 mm
ACCURACY	CL 1.0	CL 1.0	CL 1.0	CL 1.0
MOUNTING STYLES	Bottom Centre back	Every angle entry	Centre back with elbow	Bottom
PROCESS CONNECTION ²	1/2" NPT (M) 1/2" BSP (M)	1/2" NPT (M) 1/2" BSP (M)	1/2" NPT (M) 1/2" BSP (M)	3/4" NPT (M) 3/4" BSP (M)
CASE MATERIAL	AISI 304 SS AISI 316 SS ¹	AISI 304 SS AISI 316 SS ¹	AISI 304 SS AISI 316 SS ¹	Die-cast aluminum
PROTECTION CLASS	IP 65	IP 65	IP 65	IP 65
REFERENCE STANDARD	EN 13190	EN 13190	EN 13190	-
OPTIONAL EXTRAS	Silicon / Glycerin filled External zero adjustment Hermetically sealed case Shatterproof glass	Silicon / Glycerin filled Hermetically sealed case Shatterproof glass	Silicon / Glycerin filled Hermetically sealed case Shatterproof glass	SS Tag plate

Refer pages 30...32 for Thermowells.

- Notes**
1. Optional, charges extra, contact factory for details.
 2. Other connections & sizes are available, charges extra, contact factory for details.
 3. Refer "Thermometer guidance" for available ranges & knowing minimum sensor lengths. Equivalent scales available in °F, °C/°F, °F/°C.

APPLICATIONS

- Separation & isolation applications
- Viscous & corrosive media
- High-pressure applications
- High vibration application



BASIC MODEL	D101	D102	D103	D104
SPECIAL FEATURES	Forged chambers Rigid construction Laser welded diaphragm Optional exotic materials	Economical version Two piece design Laser welded diaphragm Optional exotic materials	Economical and light weight All welded construction Laser welded diaphragm	One piece construction Laser welded diaphragm Flushed diaphragm Ideal for Transmitters
TYPE	Direct coupled	Slip-ring coupled	Heavy duty seal	Flushed
RANGE (COMPATIBLE)	-1...70 bar 100...400 bar	-1...70 bar	-1...4 bar 6...70 bar 100...250 bar 400...600 bar	4...600 bar
DIAPHRAGM ³	AISI 316L SS Monel / Hastelloy C Tantalum / Titanium Inconel / Teflon Silver / Gold ⁴	AISI 316L SS Monel / Hastelloy C	AISI 316L SS Monel / Hastelloy C	AISI 316L SS
BOTTOM CHAMBER ³	AISI 316L SS Monel / Hastelloy C Tantalum / Titanium / Inconel PP / PTFE / PVC ⁵	AISI 316L SS Monel / Hastelloy C	AISI 316L SS Monel / Hastelloy C	AISI 316L SS
DIAPHRAGM & BOTTOM CHAMBER PROTECTION ³ (Max temperature 150°C)	PTFE lining - 2 mm on chamber PTFE coating, diaphragm PTFE protection, diaphragm	PTFE lining - 2 mm on chamber PTFE coating, diaphragm PTFE protection, diaphragm	-	-
FILLING FLUIDS ² (Applicable Temperatures)	Silicon DC 200 [-40°C to 205°C] Silicon DC 710 [7°C to 371°C] Food grade oil [-20°C to 140°C]	Silicon DC 200 [-40°C to 205°C] Silicon DC 710 [7°C to 371°C] Food grade oil [-20°C to 140°C]	Silicon DC 200 [-40°C to 205°C] Silicon DC 710 [7°C to 371°C] Food grade oil [-20°C to 140°C]	Silicon DC 200 [-40°C to 205°C] Silicon DC 710 [7°C to 371°C] Food grade oil [-20°C to 140°C]
PROCESS CONNECTION ¹	1/2" NPT (M) 1/2" BSP (M)	1/2" NPT (M) 1/2" BSP (M)	1/2" NPT (M) 1/2" BSP (M)	1/2"...2" size NPT (M) /BSP (M)
CAPILLARY	AISI 304 SS / AISI 316 SS	AISI 304 SS / AISI 316 SS	-	-
ARMOUR	AISI 304 SS / AISI 316 SS / PVC (Max length 6 mtrs.)	AISI 304 SS / AISI 316 SS / PVC (Max length 6 mtrs.)	-	-
OPTIONAL EXTRAS	NACE MR0175 / MR0103 Metal gasket for high pressure Integrated flushing ports	NACE MR0175 / MR0103 Integrated flushing ports DN80 version for mini systems	-	-

Refer pages 18 for Diaphragm seal guidance and 19...21 for Accessories.

- Notes**
1. Other connections & sizes are available, charges extra, contact factory for details.
 2. Other filling fluids optional, charges extra, contact factory for details.
 3. Optional, charges extra, contact factory for details.

4. Gold / silver foils over AISI 316 SS diaphragm.
5. Max pressure up to 14 bar.

APPLICATIONS

- Slurry / High viscous & corrosive media
- Separation & isolation applications
- Polymerisation applications
- High-pressure applications
- Crystalization applications



BASIC MODEL	D201	D202	D203	D204
SPECIAL FEATURES	"I" section extension type For flanges below 1½" Optional exotic materials	Flushed diaphragm Laser welded diaphragm Optional flushing ring Optional exotic materials	Large volume type design Laser welded diaphragm Optional flushing ring Optional exotic materials	Flushed diaphragm Laser welded diaphragm Optional exotic materials
TYPE	"I" section, slip-ring "I" section, retainer ring "I" section, direct coupled	Flushed	Insert	Extended neck ⁶
RANGE (COMPATIBLE)	-1...70 bar 100...400 bar	-1...250 bar	-1...250 bar -1...40 bar [PTFE lined]	-1...250 bar
DIAPHRAGM ³	AISI 316L SS Monel / Hastelloy C Tantalum / Titanium Inconel / Teflon Silver / Gold ⁴	AISI 316L SS Monel / Hastelloy C Inconel	AISI 316L SS Monel / Hastelloy C Tantalum / Titanium Inconel / Teflon Silver / Gold ⁴	AISI 316L SS Monel / Hastelloy C Inconel
BOTTOM CHAMBER ³ (Flange, extension pipe)	AISI 316L SS Monel / Hastelloy C PP / PTFE / PVC ⁵	AISI 316L SS AISI 304 SS / AISI 316 SS Monel / Hastelloy C	AISI 316L SS Monel / Hastelloy C Tantalum / Titanium / Inconel	AISI 316L SS AISI 304 SS / AISI 316 SS Monel / Hastelloy C
DIAPHRAGM & BOTTOM CHAMBER PROTECTION ³ (Max temperature 150°C)	PTFE lining - 2 mm on chamber PTFE coating, diaphragm PTFE protection, diaphragm	PTFE coating, diaphragm	PTFE lining - 2 mm on chamber PTFE coating, diaphragm PTFE protection, diaphragm	-
FILLING FLUIDS ² (Applicable Temperatures)	Silicon DC 200 [-40°C to 205°C] Silicon DC 710 [7°C to 371°C] Food grade oil [-20°C to 140°C]	Silicon DC 200 [-40°C to 205°C] Silicon DC 710 [7°C to 371°C] Food grade oil [-20°C to 140°C]	Silicon DC 200 [-40°C to 205°C] Silicon DC 710 [7°C to 371°C] Food grade oil [-20°C to 140°C]	Silicon DC 200 [-40°C to 205°C] Silicon DC 710 [7°C to 371°C] Food grade oil [-20°C to 140°C]
PROCESS CONNECTION ¹	½"...5" flange to ANSI B16.5 Rating 150#...2500#	½"...5" flange to ANSI B16.5 Rating 150#...2500#	½"...5" flange to ANSI B16.5 Rating 150#...2500#	½"...5" flange to ANSI B16.5 Rating 150#...2500#
CAPILLARY	AISI 304 SS / AISI 316 SS	AISI 304 SS / AISI 316 SS	AISI 304 SS / AISI 316 SS	AISI 304 SS / AISI 316 SS
ARMOUR	AISI 304 SS / AISI 316 SS / PVC (Max length 6 mtrs.)	AISI 304 SS / AISI 316 SS / PVC (Max length 6 mtrs.)	AISI 304 SS / AISI 316 SS / PVC (Max length 6 mtrs.)	AISI 304 SS / AISI 316 SS / PVC (Max length 6 mtrs.)
OPTIONAL EXTRAS	NACE MR0175 / MR0103 Metal gasket for high pressure Integrated flushing ports	NACE MR0175 / MR0103 Metal gasket / Mating flanges Fastners (Bolt/Nuts)	NACE MR0175 / MR0103 Metal gasket / Mating flanges Fastners (Bolt/Nuts)	NACE MR0175 / MR0103 Urea grade SS wetted parts ³ Metal gasket Fastners (Bolt/Nuts)

Refer pages 18 for Diaphragm seal guidance and 19...21 for Accessories.

- Notes**
1. Other connections & sizes are available, charges extra, contact factory for details.
 2. Other filling fluids optional, charges extra, contact factory for details.
 3. Optional, charges extra, contact factory for details.

4. Gold / silver foils over AISI 316 SS diaphragm.
5. Max pressure up to 14 bar.
6. Compatible with DN63 measuring system.

APPLICATIONS

- Food & beverages industries
- Dairy & Ice cream industries
- Pharmaceutical & cosmetic industries



BASIC MODEL	D301	D302	D303	D401
SPECIAL FEATURES	Quick connect/disconnect Laser welded flush diaphragm Tri-clamp connection	Quick connect/disconnect Laser welded flush diaphragm DIN, SMS, RJT & IDF / ISS connectionsconnections	Quick connect/disconnect Laser welded flush diaphragm DIN, SMS, RJT & IDF / ISS connectionsconnections	Floating ring design (Pulp seal) Laser welded flush diaphragm Anti-vibration connectors For paper & Pulp industries
TYPE	Sanitary, Triclamp Sanitary, Triclamp, neck type	Sanitary, flushed	Sanitary, flushed, threaded	Floating ring, flushed
RANGE (COMPATIBLE)	-1...40 bar ³	-1...40 bar (Refer detailed catalogue for range/connections or contact factory)	-1...40 bar	-1...40 bar
WETTED PARTS	AISI 316L SS	AISI 316L SS	AISI 316L SS	AISI 316L SS
FILLING FLUIDS ² (Applicable Temperatures)	Food grade oil [-20°C to 140°C] Glycerin [10°C to 150°C]	Food grade oil [-20°C to 140°C] Glycerine [10°C to 150°C]	Food grade oil [-20°C to 140°C] Glycerine [10°C to 150°C]	Silicon DC 200 [-40°C to 205°C] Silicon DC 710 [7°C to 371°C] Food grade oil [-20°C to 140°C]
PROCESS CONNECTION ¹	1½" 1" 2" 2½"	DIN [DN 25, 32, 40 & 50] SMS [1½" & 2"] RJT / APV [1½" & 2"] IDF / ISS [1½" & 2"]	DIN [DN 25, 32, 40 & 50] SMS [1½" & 2"] RJT / APV [1½" & 2"] IDF / ISS [1½" & 2"]	Floating ring as per standard
CAPILLARY ARMOUR	- -	- -	-	AISI 304 SS / AISI 316 SS AISI 304 SS / AISI 316 SS / PVC (Max length 2 mtrs.)
OPTIONAL EXTRAS	Electro-plating Tri-clamp with Gasket Bottom mating part	Electro-plating Union nut Gaskets Bottom mating part	Electro-plating Union nut Gaskets Bottom mating part	Anti-vibration spring in bottom / back Fastners (Bolt/Nuts)

Refer pages 18 for Diaphragm seal guidance and 19...21 for Accessories.

- Notes**
1. Other connections & sizes are available, charges extra, contact factory for details.
 2. Other filling fluids optional, charges extra, contact factory for details.
 3. Compatible with DN63 measuring system.

APPLICATIONS

- Slurry / high viscous & corrosive media
- Separation & isolation applications
- High-pressure applications
- Transmitter diaphragm seal refurbishment



BASIC MODEL	D402	D405	D403	D404
SPECIAL FEATURES	Flush fitment in pipeline Laser welded diaphragm Optional exotic materials	Flushed diaphragm Laser welded diaphragm Optional flushing ring Optional exotic materials	Saddle type flange Laser welded diaphragm Optional exotic materials	Economical version Compact welded body design
TYPE	Wafer/Pan cake, flange RF	Flushed, Rotatable Flange	Saddle, flange	Direct coupled, threaded
RANGE (COMPATIBLE) DIAPHRAGM ³	-1...160 bar AISI 316L SS Monel / Hastelloy C	-1...250 bar AISI 316L SS Monel / Hastelloy C / Inconel	-1...100 bar AISI 316L SS Monel / Hastelloy C	-1...21 bar ⁴ AISI 316L SS
BOTTOM CHAMBER ³	AISI 316L SS Monel / Hastelloy C	AISI 316L SS AISI 304 SS / AISI 316 SS Monel / Hastelloy C	AISI 316L SS Monel / Hastelloy C	AISI 316L SS
DIAPHRAGM & BOTTOM CHAMBER PROTECTION ³ (Max temperature 150°C)	PTFE coating, diaphragm	PTFE coating, diaphragm	-	-
FILLING FLUIDS ² (Applicable Temperatures)	Silicon DC 200 [-40°C to 205°C] Silicon DC 710 [7°C to 371°C] Food grade oil [-20°C to 140°C]	Silicon DC 200 [-40°C to 205°C] Silicon DC 710 [7°C to 371°C] Food grade oil [-20°C to 140°C]	Silicon DC 200 [-40°C to 205°C] Silicon DC 710 [7°C to 371°C] Food grade oil [-20°C to 140°C]	Silicon DC 200 [-40°C to 205°C] Silicon DC 710 [7°C to 371°C] Food grade oil [-20°C to 140°C]
PROCESS CONNECTION ¹	2" RF / FF 3" RF / FF	1½"...5" flange to ANSI B16.5 Rating 150#...2500#	2½"...14" pipe sizes	¼" NPT (M) ¼" BSP (M)
CAPILLARY	AISI 304 SS / AISI 316 SS	AISI 304 SS / AISI 316 SS	-	-
ARMOUR	AISI 304 SS / AISI 316 SS / PVC (Max length 6 mtrs.)	AISI 304 SS / AISI 316 SS / PVC (Max length 6 mtrs.)	-	-
OPTIONAL EXTRAS	Mating Flanges Gasket Fastners (Bolt/Nuts)	NACE MR0175 / MR0103 Metal gasket / Mating flanges Fastners (Bolt/Nuts)	Saddle flange Gaskets Fastners (Bolt/Nuts)	-

Refer pages 18 for Diaphragm seal guidance and 19...21 for Accessories.

- Notes**
1. Other connections & sizes are available, charges extra, contact factory for details.
 2. Other filling fluids optional, charges extra, contact factory for details.
 3. Optional, charges extra, contact factory for details.
 4. Compatible with DN50 & DN63 pressure gauges only.

DIAPHRAGM SEAL GUIDANCE

	D101	D102	D103	D104	D201	D202	D203	D204	D301	D302	D303	D401	D402	D403	D404	D405	Fluid	Suggested Materials	Fluid
P101	●	●	●	●	●	●	●	●	●	●	●	●	●	●	●	●	Acetylene	SS 316	Acetic Acid
P102	●	●	●	●	●	●	●	●	●	●	●	●	●	●	●	●	Alcohols	SS 316	Alums
P103			●	●					●	●	●					●	Amines	SS 316	Ammonia Nitrate
P104	●	●	●	●	●	●	●	●	●	●	●		●	●	●	●	Ammonia	SS 316	Arsenic Acid
P201	●	●	●	●	●	●	●	●	●	●	●		●	●	●	●	Benzene	Monel / Hastelloy C	Boric Acid
P202	●	●	●	●	●	●	●	●	●	●	●		●	●	●	●	Carbon dioxide	SS 316	Carbon Monoxide
P203	●	●	●		●	●	●		●				●	●	●	●	Chloric acid	PTFE	Borax (Sodium Borate)
P301	●	●	●		●	●	●						●		●	●	Chlorine	Hastelloy C	Carbon Tetrachloride
P302	●	●	●		●	●	●						●		●	●	Chocolate	SS 316	Cream
P303	●	●	●		●	●	●						●		●	●	Detergents	SS 316	Dyes
P401																	Diesel / Kerosene	SS 316	Diethylene Glycol
P402																	Fluorine	SS 316	Formaldehyde
P403																	Freon 22	Phosphor Bronze	Epsom salts
P404																	Freons	SS 316	Grease
P501	●	●	●		●	●	●		●	●			●		●	●	Fruit juices	SS 316	Gelatin
P502	●	●	●		●	●	●		●	●			●		●	●	Fuel oils	Hastelloy C	Hydrogen Peroxide
P503																	Gasoline / Jet fuels	SS 316	Hexane
P504																	Glues	SS 316	Honey
P601																	Hydrochloric acid	Monel / Hastelloy C	Ketones
P602																	Hydrogen sulfide	Hastelloy C	Lacquers
P603																	Milk	SS 316	Mercury
P604																	Oils	SS 316	Naphtha
P701							●										Phosphorus	Hastelloy C	Pentane
P702																	Potassium chloride	Hastelloy C	Trichloroethylene
P703		●															Propane	SS 316	Petrolatum
P704						●											Refineries	Monel / Hastelloy C	Naphthalene
P801																	Salt brine	Hastelloy C	Isopropyl Ether
P802																	Sea water	Monel	Oxalic acid
P803																	Sewage services	Hastelloy C / PTFE	Potassium Hydroxide
P804																	Soap solutions	SS 304 / Hastelloy C	Soda Ash
P901																	Sour service	Monel / Hastelloy C	Crude Oil
P902																	Sugar	SS 316	Sulfur Dioxide (dry)
P903																	Sulfuric acid	PTFE	Xylene
P904																	Transformer oil	PTFE	Urea
																	Varnish	SS 316	Toluene (Toluol)
																	Water	SS 316	Turpentine

MATERIAL COMPATIBILITY

PRESSURE GAUGE ASSEMBLY

PTFE LINING (UP TO 150°C)

<	<	x	x	<	x	x	x	x	x	x	x	x	x	x	x
-1...70 bar & 100...400 bar	-1...70 bar	-1...4 bar, 6...70 bar, 100...250 bar & 400...600 bar	4...600 bar	-1...70 bar & 100...400 bar	-1...250 bar	-1...250 bar [PTFE Lined]	-1...250 bar	-1...40 bar	1.6...40 bar & -1...21 bar	1.6...40 bar & -1...21 bar	-1...40 bar	-1...160 bar	-1...100 bar	-1...21 bar	-1...250 bar

FILLING LIQUIDS

Standard	Silicon DC 200 [-40°C to 205°C]
High temp.	Silicon DC 710 [7°C to 371°C]
Food Grade	Food grade oil [-20°C to 140°C]
Food Grade	Glycerin [10°C to 150°C]

NOTES

● = Recommended to use

It is NOT possible to connect a pulsation damper or snubber or a gauge cock / needle valve in between the diaphragm seal and the measuring instrument.

The information in this chart has been taken from other reputable sources and is to be used ONLY as a guide in selecting material for appropriate chemical compatibility.

ITEC undertake no any responsibility of the data provided in the compatibility chart.

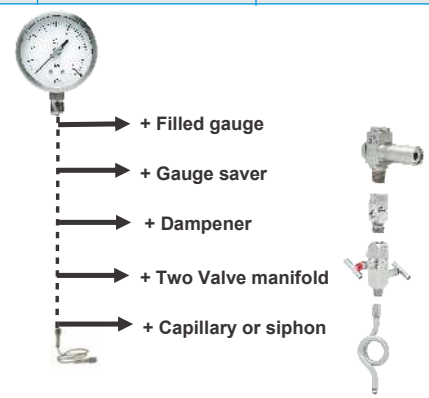

PRESSURE ACCESSORIES

SIPHON & COCKS

APPLICATIONS

- Hydraulic machines
- Boilers & compressors
- Isolation of instruments
- Heat dispenser for gauges, switches & transmitters



BASIC MODEL	A101	A102	A103	A104
SPECIAL FEATURES	Air vent hole for drain Bakelite cover on handle	3 different loop designs Seamless pipes construction Hydrotested	Economical version 2 different loop designs ERW pipes construction Thread on pipes	Economical version
TYPES	2 Way 3 Way	Coil Pigtail "U" type	Pigtail "U" type	2 Way
TEMPERATURE RATING	180°C	As per PT chart	120°C	120°C
PRESSURE RATING	100 bar	As per pipe size 3/8"...1/2" and Sch 40/80/160/STD	16 bar	16 bar
INSTRUMENT CONNECTION ²	1/4" NPT (F)...1/2" NPT (F) 1/4" BSP (F)...1/2" BSP (F)	1/4" NPT (F)...1/2" NPT (F) 1/4" BSP (F)...1/2" BSP (F) (Welded /Through adaptor /Swivel)	3/8" BSP (M) 1/2" BSP (M)	3/8" BSP (F)...1/2" BSP (F)
PROCESS CONNECTION ²	1/4" NPT (F)...1/2" NPT (F) 1/4" BSP (F)...1/2" BSP (F) 1/4" NPT (M)...1/2" NPT (M) 1/4" BSP (M)...1/2" BSP (M)	1/4" NPT (M)...1/2" NPT (M) 1/4" BSP (M)...1/2" BSP (M) 1/2"...3" flange to ANSI B16.5 Rating 150#...2500# Plain End	3/8" BSP (M) 1/2" BSP (M)	3/8" BSP (F)...1/2" BSP (F) 3/8" BSP (M)...1/2" BSP (M)
WETTED PARTS ¹	AISI 316 SS AISI 304 SS	AISI 316 SS AISI 304 SS AISI 316L SS ASTM A 105 (C.S.)	Steel (Plated)	Brass
OPTIONAL EXTRAS	NACE MR0175 IBR Certificate Oxygen Service SS Tag plate	NACE MR0175 IBR Certificate Oxygen Service SS Tag plate	Female connections through adaptors	-

Notes 1. Optional, charges extra, contact factory for details.
2. Other connections & sizes are available, charges extra, contact factory for details.

PRESSURE GAUGE ACCESSORIES

GAUGE SAFETY DEVICES

APPLICATIONS

- For gauges, switches & transmitters
- Pulsation dampener
- Over-pressure protection
- Cooling tower

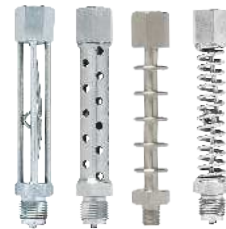

BASIC MODEL	A201	A202	A203	A204
SPECIAL FEATURES	Reduces dampening effect of process media	Adjustable ranges Bellow & Piston operated Overpressure up to 1000 bar Field adjustable optional	All SS construction 4 variable designs	All SS construction Porous metal filter disc
TYPES	Adjustable needle	Bellow (200 mbar...4 bar) Piston (≥ 6 bar)	Fin Perforated Capillary with pillar outer Capillary with coil outer	Metal filter
TEMPERATURE RATING	180°C	180°C	As per PT chart	-
PRESSURE RATING	400 bar	600 bar	As per PT chart	1000 bar
INSTRUMENT CONNECTION ²	1/4" NPT (F)...1/2" NPT (F) 1/4" BSP (F)...1/2" BSP (F)	1/4" NPT (F)...1/2" NPT (F) 1/4" BSP (F)...1/2" BSP (F)	1/4" NPT (F)...1/2" NPT (F) 1/4" BSP (F)...1/2" BSP (F)	1/4" NPT (F), 1/2" NPT (F) 1/4" BSP (F), 1/2" BSP (F)
PROCESS CONNECTION ²	1/4" NPT (M)...1/2" NPT (M) 1/4" BSP (M)...1/2" BSP (M)	1/4" NPT (M)...1/2" NPT (M) 1/4" BSP (M)...1/2" BSP (M)	1/4" NPT (M)...1/2" NPT (M) 1/4" BSP (M)...1/2" BSP (M)	1/4" NPT (M), 1/2" NPT (M) 1/4" BSP (M), 1/2" BSP (M)
WETTED PARTS ¹	AISI 316 SS AISI 304 SS AISI 316L SS Monel Hastelloy C	AISI 316 SS Monel Hastelloy C Inconel 625 SS Duplex	AISI 316 SS AISI 316L SS	AISI 316 SS Brass (Filter in AISI 316 SS)
OPTIONAL EXTRAS	NACE MR0175 Oxygen Service SS Tag plate	NACE MR0175 Oxygen Service SS Tag plate	Oxygen Service SS Tag plate	-

Notes 1. Optional, charges extra, contact factory for details.
2. Other connections & sizes are available, charges extra, contact factory for details.

DIAPHRAGM SEAL ACCESSORIES

UTILITY

APPLICATIONS

- Flushing crystalized media
- For clamping the sanitary connections
- Installation of pressure instruments
- For changing of connection size/type



				
BASIC MODEL	A301	A302	A303	A304
SPECIAL FEATURES	Dual flushing ports Flanged & in-line seal designs Optional exotic materials Standard 1/2" NPT(F) flushing ports, others optional.	V-profile for the pressure equalization while tightening Different designs as per rating Single / double bolted assembly	Assemblies available as Round union nuts Welding linears Welding males	Hydrotested Various combinations Optional exotic materials
TYPES	Flange RF Seal in-line	Standard (S) Low pressure (L) Heavy duty (H)	DIN 11851 SMS (Swedish Metric Standard) RJT (Ring Joint Type) IDF (International Dairy Federation)	Male x Female Female x Female Male X Male Swivel Flanged Adjustable
TEMPERATURE RATING	300°C ³	150°C	150°C	300°C ³
PRESSURE RATING	400 bar ⁴	S = 50 bar (Test : 120 bar) L = 25 bar (Test : 60 bar) H = 75 bar (Test : 180 bar)	As per standard	400 bar
INSTRUMENT CONNECTION ²	1/2"...5" flange RF Suitable in-line seal designs	-	As per standard	1/8"...2" Threads : NPT / BSP / BSPT
PROCESS CONNECTION ²	1/2"...5" flange RF Suitable in-line seal designs	1 1/2" 1" 2" 2 1/2"	1 1/2" 1" 2" 2 1/2"	1/8"...2" Threads : NPT / BSP / BSPT 1/2"...5" flange to ANSI B16.5 Rating 150#...2500#
WETTED PARTS OR MATERIAL OF CONSTRUCTION ¹	AISI 316 SS AISI 316L SS Monel / Hastelloy C Titanium	AISI 304 SS	AISI 304 SS AISI 316 SS	AISI 316 SS AISI 316L SS Monel Hastelloy C
OPTIONAL EXTRAS	PTFE Sealing gasket 1/4" NPT ports	Silicon sealing gasket Bottom mating part	Silicon sealing gasket Bottom mating part	Oxygen service PTFE sealing gaskets

- Notes**
1. Optional, charges extra, contact factory for details.
 2. Other connections & sizes are available, charges extra, contact factory for details.
 3. Or as per exotic material specifications.
 4. Or as per diaphragm seal design specifications.

RESISTANCE TEMPERATURE DETECTOR

INDUSTRIAL

APPLICATIONS

- Power & Utilities
- Oil & gas application
- Chemical & petrochemical
- Water, waste-water treatment
- Bearing temperature measurement



BASIC MODEL	R101	R102	R103	R104
SPECIAL FEATURES	Nipple extension Mineral insulated Exchangeable insert Spring loaded design	Nipple-Union-Nipple extension Mineral insulated Exchangeable insert Spring loaded design	Fixed extension Mineral insulated Exchangeable insert Spring loaded design	Adjustable extension Mineral insulated Exchangeable insert Spring loaded design
CONNECTION TYPE	Nipple	Nipple-Union-Nipple	Fixed	Adjustable
SENSOR ² (Simplex/Duplex)	Pt-100 Pt-500, Pt-1000	Pt-100 Pt-500, Pt-1000	Pt-100 Pt-500, Pt-1000	Pt-100 Pt-500, Pt-1000
RANGE ²	-200°C up to 400°C -200°C up to 600°C	-200°C up to 400°C -200°C up to 600°C	-200°C up to 400°C -200°C up to 600°C	-200°C up to 400°C -200°C up to 600°C
ACCURACY ²	Class B Class A	Class B Class A	Class B Class A	Class B Class A
SHEATH DIAMETER	6 mm / 6.35 mm (1/4") 3 mm ¹ , 8 mm	6 mm / 6.35 mm (1/4") 3 mm ¹ , 8 mm	6 mm / 6.35 mm (1/4") 3 mm ¹ , 8 mm	6 mm / 6.35 mm (1/4") 3 mm ¹ , 8 mm
SHEATH MATERIAL ²	AISI 316 SS AISI 316L SS / AISI 316Ti SS	AISI 316 SS AISI 316L SS / AISI 316Ti SS	AISI 316 SS AISI 316L SS / AISI 316Ti SS	AISI 316 SS AISI 316L SS / AISI 316Ti SS
ENCLOSURE PROTECTION ²	IP 65 IP 67 / IP 68 Flameproof / Ex-proof	IP 65 IP 67 / IP 68 Flameproof / Ex-proof	IP 65 IP 67 / IP 68 Flameproof / Ex-proof	IP 65 IP 67 / IP 68 Flameproof / Ex-proof
ENCLOSURE MATERIAL ²	Die-cast aluminum AISI 304 SS AISI 316 SS	Die-cast aluminum AISI 304 SS AISI 316 SS	Die-cast aluminum AISI 304 SS AISI 316 SS	Die-cast aluminum AISI 304 SS AISI 316 SS
PROCESS CONNECTION ³	1/2" BSP (M) 1/2" NPT (M)	1/2" BSP (M) 1/2" NPT (M)	1/2" BSP (M) 1/2" NPT (M) 1/4" NPT (M) / 1/4" BSP (M) ⁴	1/2" BSP (M) 1/2" NPT (M) 1/4" NPT (M) / 1/4" BSP (M) ⁴
REFERENCE STANDARD	IEC 751 / DIN 43760	IEC 751 / DIN 43760	IEC 751 / DIN 43760	IEC 751 / DIN 43760
APPROVAL	ATEX, CSA & FM (Enclosure)	ATEX, CSA & FM (Enclosure)	ATEX, CSA & FM (Enclosure)	ATEX, CSA & FM (Enclosure)
OPTIONAL EXTRAS	Various cable glands Transmitter 4...20mA output Various Compensating cables	Various cable glands Transmitter 4...20mA output Various Compensating cables	Various cable glands Transmitter 4...20mA output Various Compensating cables	Various cable glands Transmitter 4...20mA output Various Compensating cables

Refer pages 29 for RTD & TC general information and 30...32 for Thermowells.

- Notes**
1. With simplex element only.
 2. Optional, charges extra, contact factory for details.
 3. Other connections & sizes are available, charges extra, contact factory for details.

4. Applicable for 3 mm & 6 mm sheath diameters.
5. Minimum sensing length = 30 mm.

RESISTANCE TEMPERATURE DETECTOR

INSERTS

APPLICATIONS

- Nuclear applications
- Autoclave applications
- Steel & Power applications
- Power & utility applications
- Pharmaceutical applications
- Turbines / Bearing Temperature
- Spares / replacement assembly
- Pumps, compressors & diesel engines



BASIC MODEL	R201	R202	R203	R204
SPECIAL FEATURES	Transition joint type Mineral insulated Crimp-on-pot sealed ISO threaded pot Adjustable / fixed connection	Plug & Jack Connection Mineral insulated OMEGA / LIMO connectors Simplex configuration Adjustable connection	Mineral insulated Spring Loaded Design Ceramic block with Ni-plated / Silver plated terminals	With Flexible Cable Various designs of Hot ends Bearing temperature RTD
COLD END TERMINATION	Compensating cable	Plug & Jack	Spring loaded terminal block	Compensating cable
SENSOR ² (Simplex/Duplex)	Pt-100 Pt-500, Pt-1000	Pt-100 Pt-500, Pt-1000	Pt-100 Pt-500, Pt-1000	Pt-100 Pt-500, Pt-1000
RANGE ²	-200°C up to 400°C -200°C up to 600°C	-200°C up to 400°C -200°C up to 600°C	-200°C up to 400°C -200°C up to 600°C	-200°C up to 400°C -200°C up to 600°C
ACCURACY ²	Class B Class A	Class B Class A	Class B Class A	Class B Class A
SHEATH DIAMETER	6 mm / 6.35 mm (1/4") 3 mm/3.2 mm ¹ , 8 mm	6 mm / 6.35 mm (1/4") 3 mm, 8 mm	6 mm / 6.35 mm (1/4") 3 mm ¹ , 8 mm	3 mm/3.2 mm ¹ 6 mm / 6.35 mm (1/4")
SHEATH MATERIAL ²	AISI 316 SS AISI 316L SS / AISI 316Ti SS	AISI 316 SS AISI 316L SS / AISI 316Ti SS	AISI 316 SS AISI 316L SS / AISI 316Ti SS	AISI 316 SS AISI 316L SS
PROCESS CONNECTION ³	1/2" BSP (M) 1/2" NPT (M) 1/4" NPT (M) / 1/4" BSP (M) ⁴	1/2" BSP (M) 1/2" NPT (M) 1/4" NPT (M) / 1/4" BSP (M) ⁴	-	-
REFERENCE STANDARD	IEC 751 / DIN 43760	IEC 751 / DIN 43760	IEC 751 / DIN 43760	IEC 751 / DIN 43760
OPTIONAL EXTRAS	PTFE/PTFE cables PTFE/PTFE/SS braided cables FG/FG/SS braided cables PTFE/PTFE/Silicon cables	Various types of connectors Female connector with various types of compensating cables	Terminal block PCD 33 mm Terminal block PCD 46 mm Transmitter 4...20mA output	PTFE/PTFE cables PTFE/PTFE/SS braided cables FG/FG/SS braided cables PTFE/PTFE/Silicon cables

Refer pages 29 for RTD & TC general information and 30...32 for Thermowells.

- Notes**
1. With simplex element only.
 2. Optional, charges extra, contact factory for details.
 3. Other connections & sizes are available, charges extra, contact factory for details.

4. Applicable for 3 mm & 6 mm sheath diameters.
5. Minimum sensing length = 30 mm.





RESISTANCE TEMPERATURE DETECTOR

INDUSTRY SPECIFIC

APPLICATIONS

- Cement Industries
- Air & flue gas applications
- Steel & Power applications
- Refinery & Petrochemicals Plants
- Pharmaceutical, Food & Beverages
- Stator winding of motors & generators
- Surface measurement in refractory vessels



				
BASIC MODEL	R301	R302/R303	R304	R305
SPECIAL FEATURES	Weld-Pad connection Mineral insulated Exchangeable insert Spring loaded design	Threaded / flanged connection Protecting Tube Mineral insulated element Spring loaded design Fixed / adjustable connection	Tri-clover connection Mineral insulated Exchangeable insert Spring loaded design	Rectangular, flat & laminated Electrically shielded sensor High dielectric constant
CONNECTION TYPE	Weld-pad	Threaded / Flanged	Sanitary	-
SENSOR ² (Simplex/Duplex)	Pt-100 Pt-500, Pt-1000	Pt-100 Pt-500, Pt-1000	Pt-100 Pt-500, Pt-1000	Pt-100 Pt-500, Pt-1000
RANGE ²	-200°C up to 400°C -200°C up to 600°C	-200°C up to 400°C -200°C up to 600°C	-200°C up to 400°C -200°C up to 600°C	-200°C up to 400°C -200°C up to 600°C
ACCURACY ²	Class B Class A	Class B Class A	Class B Class A	Class B Class A
SHEATH DIAMETER	6 mm / 6.35 mm (1/4") 8 mm	6 mm / 6.35 mm (1/4") 3 mm ¹ , 8 mm	6 mm / 6.35 mm (1/4") 3 mm ¹ , 8 mm	7 x 50 x 1.5 mm (Min) 25 x 450 x 3.5 mm (Max) Fiber Glass
SHEATH MATERIAL (WELD PAD)	AISI 316 SS AISI 316L SS	AISI 316 SS AISI 316L SS	AISI 316 SS AISI 316L SS	Fiber Glass
ENCLOSURE PROTECTION	IP 65 IP 67 / IP 68 Flameproof / Ex-proof	IP 65 IP 67 / IP 68 Flameproof / Ex-proof	IP 65 IP 67 / IP 68 Flameproof / Ex-proof	IP 65
ENCLOSURE MATERIAL ²	Die-cast aluminum AISI 304 SS AISI 316 SS	Die-cast aluminum AISI 304 SS AISI 316 SS	Die-cast aluminum AISI 304 SS AISI 316 SS	-
PROCESS CONNECTION ³	Weld Pad (25 x 25 x 50) Weld Pad (25 x 25 x 100) Weld Pad (50 x 50 x 100)	3/4"NPT (M) 1 1/2" RF 150# ANSI B16.5	1.5" 1" 2"	-
PROTECTION TUBE ²	-	1/2"sch40	-	-
REFERENCE STANDARD	IEC 751 / DIN 43760	IEC 751 / DIN 43760	IEC 751 / DIN 43760	IEC 751 / DIN 43760
APPROVAL	ATEX, CSA & FM (Enclosure)	ATEX, CSA & FM (Enclosure)	ATEX, CSA & FM (Enclosure)	-
OPTIONAL EXTRAS	Surface / Bracket mounting 2" Yoke/ Pipe mounting Various cable glands Transmitter 4...20mA output Various compensating cables	Various cable glands Transmitter 4...20mA output Various compensating cables	Various cable glands Transmitter 4...20mA output Various compensating cables Electro-plating Tri-clamp with Gasket Bottom mating part	PTFE/PTFE cables PTFE/PTFE/Silicon cables

Refer pages 29 for RTD & TC general information and 30...32 for Thermowells.

- Notes**
1. With simplex element only.
 2. Optional, charges extra, contact factory for details.
 3. Other connections & sizes are available, charges extra, contact factory for details.

APPLICATIONS

- Power & Utilities
- Oil & gas application
- Chemical & petrochemical
- Water, waste-water treatment
- Bearing temperature measurement



BASIC MODEL	T101	T102	T103	T103
SPECIAL FEATURES	Nipple extension Mineral insulated Exchangeable insert Spring loaded design	Nipple-Union-Nipple extension Mineral insulated Exchangeable insert Spring loaded design	Fixed extension Mineral insulated Exchangeable insert Spring loaded design	Adjustable extension Mineral insulated Exchangeable insert Spring loaded design
CONNECTION TYPE	Nipple	Nipple-Union-Nipple	Fixed	Adjustable
SENSOR ² (Simplex/Duplex)	K J, E, T, N, R, S, B	K J, E, T, N, R, S, B	K J, E, T, N, R, S, B	K J, E, T, N, R, S, B
ACCURACY ²	Standard Special	Standard Special	Standard Special	Standard Special
HOT END TERMINATION	Ungrounded Grounded	Ungrounded Grounded	Ungrounded Grounded	Ungrounded Grounded
SHEATH DIAMETER	6 mm / 6.35 mm (1/4") 3 mm, 4.8 mm, 8 mm & 12.7 mm (1/2")	6 mm / 6.35 mm (1/4") 3 mm, 4.8 mm, 8 mm & 12.7 mm (1/2")	6 mm / 6.35 mm (1/4") 3 mm, 4.8 mm, 8 mm & 12.7 mm (1/2")	6 mm / 6.35 mm (1/4") 3 mm, 4.8 mm, 8 mm & 12.7 mm (1/2")
SHEATH MATERIAL ²	AISI 316 SS AISI 316L SS Inconel 600 / Inconel 800	AISI 316 SS AISI 316L SS Inconel 600 / Inconel 800	AISI 316 SS AISI 316L SS Inconel 600 / Inconel 800	AISI 316 SS AISI 316L SS Inconel 600 / Inconel 800
ENCLOSURE PROTECTION ²	IP 65 IP 67 / IP 68 Flameproof & Ex-proof	IP 65 IP 67 / IP 68 Flameproof & Ex-proof	IP 65 IP 67 / IP 68 Flameproof & Ex-proof	IP 65 IP 67 / IP 68 Flameproof & Ex-proof
ENCLOSURE MATERIAL ²	Die-cast aluminum AISI 304 SS AISI 316 SS	Die-cast aluminum AISI 304 SS AISI 316 SS	Die-cast aluminum AISI 304 SS AISI 316 SS	Die-cast aluminum AISI 304 SS AISI 316 SS
PROCESS CONNECTION ³	1/2" BSP (M) 1/2" NPT (M)	1/2" BSP (M) 1/2" NPT (M)	1/2" BSP (M) 1/2" NPT (M) 1/4" NPT (M) / 1/4" BSP (M) ⁴	1/2" BSP (M) 1/2" NPT (M) 1/4" NPT (M) / 1/4" BSP (M) ⁴
REFERENCE STANDARD	IEC 548.2 / ANSI MC 96.1	IEC 548.2 / ANSI MC 96.1	IEC 548.2 / ANSI MC 96.1	IEC 548.2 / ANSI MC 96.1
APPROVAL	ATEX, CSA & FM (Enclosure)	ATEX, CSA & FM (Enclosure)	ATEX, CSA & FM (Enclosure)	ATEX, CSA & FM (Enclosure)
OPTIONAL EXTRAS	Various cable glands Transmitter 4...20mA output Various Extension cables	Various cable glands Transmitter 4...20mA output Various Extension cables	Various cable glands Transmitter 4...20mA output Various Extension cables	Various cable glands Transmitter 4...20mA output Various Extension cables

Refer pages 29 for RTD & TC general information and 30...32 for Thermowells.

- Notes**
1. Check guidance chart before selecting the element type.
 2. Optional, charges extra, contact factory for details.
 3. Other connections & sizes are available, charges extra, contact factory for details.
 4. Applicable for 3 mm, 4.8 mm & 6 mm sheath diameters.

APPLICATIONS

- Plastic Industries
- Reactor application
- Moulding Machines
- Aero-space application
- Pharmaceutical applications
- Water, waste-water treatment
- Spares / replacement assembly
- Steel, Power & Nuclear applications



BASIC MODEL	T201	T202	T203	T204
SPECIAL FEATURES	Bare Conductor termination Mineral insulated High temperature application	Transition joint type Mineral insulated Crimp-on-pot sealed ISO threaded pot Adjustable / fixed connection	Plug & Jack Connection Mineral insulated OMEGA / LEMO connectors Simplex configuration Adjustable connection	Mineral insulated Spring Loaded Design Cermic block with Ni-plated / Silver plated terminals
COLD END TERMINATION	Bare conductors	Extension cable	Plug & Jack	Spring loaded terminal block
SENSOR ² (Simplex/Duplex)	K J, E, T, N	K J, E, T, N	K J, E, T, N	K J, E, T, N
ACCURACY ²	Standard Special	Standard Special	Standard Special	Standard Special
HOT END TERMINATION	Ungrounded Grounded	Ungrounded Grounded	Ungrounded Grounded	Ungrounded Grounded
SHEATH DIAMETER	6 mm / 6.35 mm (1/4") 3 mm, 4.8 mm, 8 mm & 12.7 mm (1/2")	6 mm / 6.35 mm (1/4") 3 mm, 4.8 mm, 8 mm & 12.7 mm (1/2")	3 mm 1 mm, 1.5 mm, 6 mm	6 mm / 6.35 mm (1/4") 3 mm, 4.8 mm, 8 mm & 12.7 mm (1/2")
SHEATH MATERIAL ²	AISI 316 SS AISI 316L SS Inconel 600 / Inconel 800	AISI 316 SS AISI 316L SS Inconel 600 / Inconel 800	AISI 316 SS AISI 316L SS Inconel 600 / Inconel 800	AISI 316 SS AISI 316L SS Inconel 600 / Inconel 800
PROCESS CONNECTION ³	-	1/2" BSP (M) 1/2" NPT (M) 1/4" NPT (M) / 1/4" BSP (M) ⁴	1/2" BSP (M) 1/2" NPT (M) 1/4" NPT (M) / 1/4" BSP (M) ⁴	-
REFERENCE STANDARD	IEC 548.2 / ANSI MC 96.1	IEC 548.2 / ANSI MC 96.1	IEC 548.2 / ANSI MC 96.1	IEC 548.2 / ANSI MC 96.1
OPTIONAL EXTRAS	SS Tag plate	PTFE/PTFE cables PTFE/PTFE/SS braided cables FG/FG/SS braided cables	Various types of connectors Female connector with various types of Extension cables	Terminal block PCD 33 mm Terminal block PCD 46 mm Transmitter 4...20mA output cables

Refer pages 29 for RTD & TC general information and 30...32 for Thermowells.

- Notes**
1. Check guidance chart before selecting the element type.
 2. Optional, charges extra, contact factory for details.
 3. Other connections & sizes are available, charges extra, contact factory for details.
 4. Applicable for 3 mm, 4.8 mm & 6 mm sheath diameters.

APPLICATIONS

- Textile Industries
- Clean room validation
- Blow moulding machine
- Limit space applications
- Injection moulding machine
- Trust plates & motor winding
- Plastic & packing industries
- Spares / replacement assembly

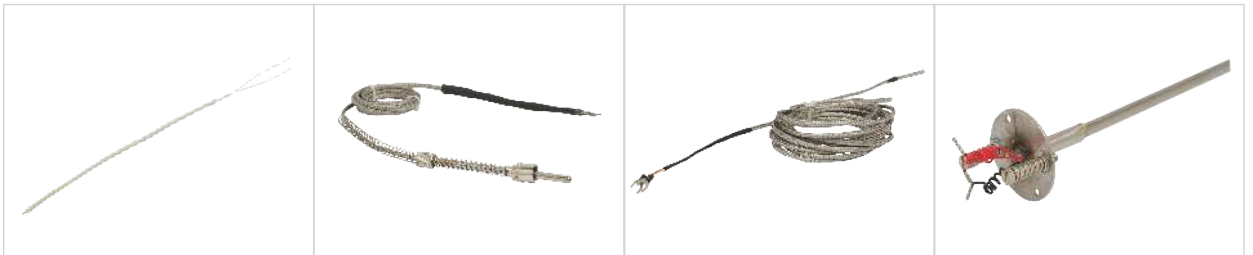

BASIC MODEL	T205	T206	T207	T208
SPECIAL FEATURES	Economical Version Bare Wire Thermocouple	Bayonet Fitting Spring loaded design Flexible Cable	Flexible Cables Fast response time With spring loaded mounting and retaining thrust washer	Spring Loaded Design Provide with SS Base plate for mounting the temperature Transmitter
COLD END TERMINATION SENSOR ² (Simplex/Duplex)	Ceramic terminal block K J, E, T, N, R, S, B	Extension cable J K	Extension cable K T	SS base plate K J, E, T, N, R, S, B
ACCURACY ²	Standard Special	Standard Special	Standard Special	Standard Special
HOT END TERMINATION	Exposed	Grounded	Ungrounded Grounded	Ungrounded Grounded
SHEATH DIAMETER ²	12 mm 8 mm	6 mm / 6.35 mm (1/4") 3 mm, 4.8 mm, 8 mm & 12.7 mm (1/2")	3 mm 6mm, 8 mm	6 mm / 6.35 mm (1/4") 3 mm, 4.8 mm, 8 mm & 12.7 mm (1/2")
SHEATH MATERIAL ²	Ceramic Insulators (KER610 / KER710)	AISI 316 SS	AISI 316 SS	AISI 316 SS AISI 316L SS Inconel 600 / Inconel 800
PROCESS CONNECTION ³	-	Bayonet connection	-	-
REFERENCE STANDARD	IEC 548.2 / ANSI MC 96.1	IEC 548.2 / ANSI MC 96.1	IEC 548.2 / ANSI MC 96.1	IEC 548.2 / ANSI MC 96.1
OPTIONAL EXTRAS	SS Tag plate Terminal head	PTFE/PTFE cables PTFE/PTFE/SS braided cables FG/FG/SS braided cables	PTFE/PTFE cables PTFE/PTFE/SS braided cables FG/FG/SS braided cables	Transmitter 4...20mA output

Refer pages 29 for RTD & TC general information and 30...32 for Thermowells.

- Notes**
1. Check guidance chart before selecting the element type.
 2. Optional, charges extra, contact factory for details.
 3. Other connections & sizes are available, charges extra, contact factory for details.

APPLICATIONS

- Air & flue gas applications
- Steel & Power applications
- Glass & Cement Industries
- Refinery & Petrochemicals Plants
- Pharmaceutical, Food & Beverages
- Stator winding of motors & generators
- Surface measurement in refractory vessels
- Skin temperature measurement of Heater Tube



BASIC MODEL	T301	T302	T303	T304
SPECIAL FEATURES	Ceramic Insulator Single / Double protecting tube Exchangeable insert KER710 / KER610 Adjustable / Fixed Flange	Ceramic Insulator Single / Double protecting tube Exchangeable insert KER710 Material Adjustable / Fixed Connection	Weld-Pad connection Mineral insulated Exchangeable insert Spring loaded design	Threaded / flanged connection Protecting Tube Mineral insulated element Beaded type element Spring loaded design Fixed / adjustable connection
CONNECTION TYPE	Flanged	Threaded	Weld-pad	Threaded / Flanged
SENSOR ² (Simplex/Duplex)	R	R	K	K
ACCURACY ²	K,N,S, B	K,N,S, B	J,E,T,N	J, E,T,N, R,S, B
HOT END TERMINATION	Standard Special	Standard Special	Standard Special	Standard Special
SHEATH DIAMETER (Other optional sizes)	Ungrounded Grounded	Ungrounded Grounded	Ungrounded Grounded	Ungrounded Grounded
SHEATH MATERIAL ² (WELD PAD)	26 AWG 25 AWG, 24 AWG	26 AWG 25 AWG, 24 AWG	6 mm / 6.35 mm (1/4") 3 mm, 4.8 mm, 8 mm & 12.7 mm (1/2")	6 mm / 6.35 mm (1/4") 3 mm, 4.8 mm, 8 mm & 12.7 mm (1/2")
ENCLOSURE PROTECTION ²	Ceramic (KER610 / KER710)	Ceramic (KER610 / KER710)	AISI 316 SS AISI 316L SS Inconel 600 / Inconel 800	AISI 316 SS AISI 316L SS Inconel 600 / Inconel 800
ENCLOSURE MATERIAL ²	IP 65 IP 67 / IP 68 Flameproof & Ex-proof	IP 65 IP 67 / IP 68 Flameproof & Ex-proof	IP 65 IP 67 / IP 68 Flameproof & Ex-proof	IP 65 IP 67 / IP 68 Flameproof & Ex-proof
PROCESS CONNECTION ³	Die-cast aluminum AISI 304 SS AISI 316 SS	Die-cast aluminum AISI 304 SS AISI 316 SS	Die-cast aluminum AISI 304 SS AISI 316 SS	Die-cast aluminum AISI 304 SS AISI 316 SS
PROTECTION TUBE ²	1 1/2" ... 5" flange to ANSI B16.5 Rating 150#...2500#	3/4" NPT (M)...1" NPT (M) 3/4" BSP (M)...1" BSP (M)	Weld Pad (25 x 25 x 50) Weld Pad (25 x 25 x 100) Weld Pad (50 x 50 x 100)	3/4" NPT (M)...1" NPT (M) 1 1/2" ... 5" flange to ANSI B16.5 Rating 150#...2500#
REFERENCE STANDARD APPROVAL	Φ12 x 2 mm + Φ20 x 2.5 mm Φ15 x 2.5 mm + Φ24 x 3 mm (INNER + OUTER)	Φ12 x 2 mm + Φ20 x 2.5 mm Φ15 x 2.5 mm + Φ24 x 3 mm (INNER + OUTER)	-	3/8" Sch 40...3/4" Sch 80
OPTIONAL EXTRAS	IEC 548.2 / ANSI MC 96.1 ATEX, CSA & FM (Enclosure)	IEC 548.2 / ANSI MC 96.1 ATEX, CSA & FM (Enclosure)	IEC 548.2 / ANSI MC 96.1 ATEX, CSA & FM (Enclosure)	IEC 548.2 / ANSI MC 96.1 ATEX, CSA & FM (Enclosure)
	Various cable glands Transmitter 4...20mA output Various Extension cables Protection tube in Kanthal / Silicon carbide / Silicon nitrate bonded	Various cable glands Transmitter 4...20mA output Various Extension cables Protection tube in Kanthal / Silicon carbide / Silicon nitrate bonded	Surface / Bracket mounting 2" Yoke / Pipe mounting Various cable glands Transmitter 4...20mA output Various Extension cables	Various cable glands Transmitter 4...20mA output Various Extension cables Protection tubes coated with Tungsten carbide / Stellite / Ceramic

Refer pages 29 for RTD & TC general information and 30...32 for Thermowells.

- Notes**
1. Check guidance chart before selecting the element type.
 2. Optional, charges extra, contact factory for details.
 3. Other connections & sizes are available, charges extra, contact factory for details.

Thermocouple element characteristics

ANSI Code	ANSI MC 96.1 Color Coding		Alloy Combination		Maximum T/C Grade Temp. Range	IEC 584-3 Color Coding		IEC Code
	Thermocouple Grade	Extension Grade	+ Lead	- Lead		Thermocouple Grade	Intrinsically Safe	
J			IRON Fe (magnetic)	CONSTANTAN COPPER-NICKEL Cu-Ni	-210 to 1200°C -346 to 2193°F			J
K			NICKEL-CHROMIUM Ni-Cr	NICKEL-ALUMINUM Ni-Al (magnetic)	-270 to 1372°C -454 to 2501°F			K
T			COPPER Cu	CONSTANTAN COPPER-NICKEL Cu-Ni	-270 to 400°C -454 to 752°F			T
E			NICKEL-CHROMIUM Ni-Cr	CONSTANTAN COPPER-NICKEL Cu-Ni	-270 to 1000°C -454 to 1832°F			E
N			NICROSIL Ni-Cr-Si	NISIL Ni-Si-Mg	-270 to 1300°C -450 to 2372°F			N
R	NONE ESTABLISHED		PLATINUM-13% RHODIUM Pt-13% Rh	PLATINUM Pt	-50 to 1768°C -58 to 3214°F			R
S	NONE ESTABLISHED		PLATINUM-10% RHODIUM Pt-10% Rh	PLATINUM Pt	-50 to 1768°C -58 to 3214°F			S
U	NONE ESTABLISHED		COPPER Cu	COPPER-LOW NICKEL Cu-Ni				U
B	NONE ESTABLISHED		PLATINUM-30% RHODIUM Pt-30% Rh	PLATINUM-6% RHODIUM Pt-6% Rh	0 to 1820°C 32 to 3308°F			B





RTD tolerance chart

Temperature °C	Resistance Value Ω	Tolerance DIN-IEC-751	
		Class A °C (Ω)	Class B °C (Ω)
-200	18.52	±0.55-(±0.24)	±1.3-(±0.56)
-100	60.26	±0.35-(±0.14)	±0.8-(±0.32)
0	100.00	±0.15-(±0.06)	±0.3-(±0.12)
100	138.51	±0.35-(±0.13)	±0.8-(±0.30)
200	175.86	±0.55-(±0.20)	±1.3-(±0.48)
300	212.05	±0.75-(±0.27)	±1.8-(±0.64)
400	247.09	±0.95-(±0.33)	±2.3-(±0.79)
500	280.98	±1.15-(±0.38)	±2.8-(±0.93)
600	313.71	±1.35-(±0.43)	±3.3-(±1.06)
650	329.64	±1.45-(±0.46)	±3.6-(±1.13)

APPLICATIONS

- Air & flue gas
- Tanks & vessels
- Oil & Gas applications
- Corrosive environments
- Power & Steel industries
- HVAC, Air filters & utilities
- On-shore/Off-shore application



				
BASIC MODEL	W101	W102	W103	W104
SPECIAL FEATURES	Fabricated	Solid bar-stock drilled design	Fabricated	Solid bar-stock drilled design
CONNECTION TYPE	Threaded	Threaded	Flanged	Flanged
SHANK FORM	Straight	Straight Straight reduced tip Partial taper Full taper	Straight	Straight Straight reduced tip Partial taper Full taper
MATERIAL OF CONSTRUCTION ¹	SS 304 / 310 / 316 / 316L	SS 304 / 310 / 316 / 316L / 446 Inconel 600 / 800 / 625 / 825 Monel, Hastelloy C, Titanium Alloy 20, ASTM A105	SS 304 / 310 / 316 / 316L	SS 304 / 310 / 316 / 316L / 446 Inconel 600 / 800 / 625 / 825 Monel, Hastelloy C, Titanium Alloy 20, ASTM A105
INSTRUMENT CONNECTION	3/8" NPT (F)...2" NPT (F) 3/8" BSP (F)...2" BSP (F)	3/8" NPT (F)...2" NPT (F) 3/8" BSP (F)...2" BSP (F)	1/2" NPT (F)...1" NPT (F) 1/2" BSP (F)...1" BSP (F)	1/2" NPT (F)...1" NPT (F) 1/2" BSP (F)...1" BSP (F)
PROCESS CONNECTION ²	3/8" NPT (M)...2" NPT (M) 3/8" BSP (M)...2" BSP (M)	3/8" NPT (M)...2" NPT (M) 3/8" BSP (M)...2" BSP (M)	1 1/2"...5" flange to ANSI B16.5 Rating 150#...2500#	1 1/2"...5" flange to ANSI B16.5 Rating 150#...2500#
BORE SIZES ¹	7x10 mm, 7x12 mm, 9x14 mm 10x12 mm, 12x14 mm 12x16 mm Or pipe 1/8"...1/2", Sch 40...160	6.6 mm / 7 mm 9 mm, 9.6 mm, 11 mm & 13 mm	1/8"...1/2", Sch 40...160	6.6 mm / 7 mm 9 mm, 9.6 mm, 11 mm & 13 mm
HEAD TYPE	Hex Round with spanner slots	Hex Round with spanner slots	Round	Hex Round
EXTENSION LENGTH ³	45 mm	50 mm	50 mm	50 mm
INSERTION LENGTH ³ (Below thread/flange)	Up to 1000 mm	1000 mm (Max.) 300 mm (Max. for Hex type)	Up to 1000 mm	1000 mm (Max.)
OPTIONAL EXTRAS	-	Wake Frequency Calculation Plug & chain in AISI 304 SS	Plug & chain in AISI 304 SS Shank lining & coating Sleeve on shank & flange RF	Shank lining & coating Overlay of flange RF Sleeve on shank & flange RF Wake Frequency Calculation

Refer page 30 for Thermowell Guidance.

- Notes**
1. Check guidance chart before selecting the element type.
 2. Other connections & sizes are available, charges extra, contact factory for details.
 3. Optional, charges extra, contact factory for details.

APPLICATIONS

- Food & beverages
- Oil & Gas applications
- Corrosive environments
- Power & Steel industries
- Sterile process industries
- On-shore/Off-shore application
- Biochemical & pharmaceutical Industries



BASIC MODEL	W201	W202	W203	W204
SPECIAL FEATURES	Van-stone design Single piece forged drilled	Sanitary design Solid bar-stock drilled	Weld-in / Socket-weld design Solid bar-stock drilled	Partial bar-stock Flanged process connection
CONNECTION TYPE	Flange RF	Sanitary, Triclover	Weld-in / Socket-weld	Flanged
SHANK FORM	Straight Straight reduced tip Partial taper Full taper	Straight Straight reduced tip Partial taper Full taper	Straight Straight reduced tip Partial taper Full taper	Straight Straight reduced tip Partial taper
MATERIAL OF CONSTRUCTION ¹	AISI 316 SS / AISI 316L SS Inconel 600 / Inconel 625 Monel 400 / Hastelloy C	AISI 316 SS AISI 304 SS AISI 316L SS	AISI 316 SS / AISI 316L SS ASTM F11 / F22 / F91 Inconel 600 / Inconel 625	SS 304 / 310 / 316 / 316L / 446 Inconel 600 / 800 / 625 / 825 Monel, Hastelloy C, Titanium Alloy 20, ASTM A105
INSTRUMENT CONNECTION	1/2" NPT (F) 1/2" BSP (F)	3/8" NPT (F)...3/4" NPT (F) 3/8" BSP (F)...3/4" BSP (F)	1/2" NPT (F)...1" NPT (F) 1/2" BSP (F)...1" BSP (F)	1/2" NPT (F)...1" NPT (F) 1/2" BSP (F)...1" BSP (F)
PROCESS CONNECTION ²	1" ANSI flange RF 1 1/2" ANSI flange RF 2" ANSI flange RF	1 1/2" Sanitary seal 2" Sanitary seal 2 1/2" Sanitary seal	As per customer requirement	1 1/2"...5" flange to ANSI B16.5 Rating 150#...2500#
BORE SIZES ¹	6.6 mm / 7 mm 9 mm, 9.6 mm, 11 mm & 13 mm	6.6 mm / 7 mm 9 mm, 9.6 mm, 11 mm & 13 mm	6.6 mm / 7 mm 9 mm, 9.6 mm, 11 mm & 13 mm	6.6 mm / 7 mm 9 mm, 9.6 mm, 11 mm & 13 mm
HEAD TYPE	Round	Round with spanner slots	Round	Round
EXTENSION LENGTH ³	45 mm	50 mm	50 mm	50 mm
INSERTION LENGTH ³ (Below thread/flange)	1000 mm (Max.)	1000 mm (Max.)	1000 mm (Max.)	Up to 1000 mm
SPECIAL OPTIONS	Electro polishing Wake frequency calculation Cover flange (Lap joint type)	Electro polishing Tri-clamp with Gasket	Plug & chain in AISI 304 SS Wake frequency calculation	Shank lining & coating Overlay of flange RF Sleeve on shank & flange RF

Refer page 30 for Thermowell Guidance.

- Notes**
1. Check guidance chart before selecting the element type.
 2. Other connections & sizes are available, charges extra, contact factory for details.
 3. Optional, charges extra, contact factory for details.

THERMOWELL GUIDANCE

Thermowell is a safety / protection accessory for the sensor part of the temperature measuring, indicating & controlling instruments in corrosive & high pressure areas. They are applicable in all kind of fluid areas. A critical advantage of the thermowell is that, it provides the media isolation for the purpose of maintenance / replacement of the instruments.

ITEC manufacture various types of thermowells; such as,

1. Threaded/Flanged type
2. Van-stone type
3. Socket-weld/weld-in type
4. Sanitary type
5. Multi-piece type

With reference to the shank design thermowell, further classified into,

1. Straight type
2. Reduced-tip type
3. Partial taper type
4. Taper type

ITEC thermowells are machined in CNCs and Deep Gun-drilling machines and available in a variety of stainless steel types. All welds between the flange & well are full penetration welded.

ITEC manufactures thermowells also in exotic materials like Monel, Hastelloy C, titanium, etc and variety of exotic materials and special grades alloys.

ITEC also provide lining or coating on the well/wetted parts, exotic material overlay on flange RF and sleeves for the wells for its thermowells.

Some of the in-house tests are,

1. Wake frequency calculation
2. Hydrostatic test
3. Dye Penetration test
4. Dimensional check

All other tests are conducted at a third party labs, ITEC provide conformity certificate.

Nomenclature of Thermowell:

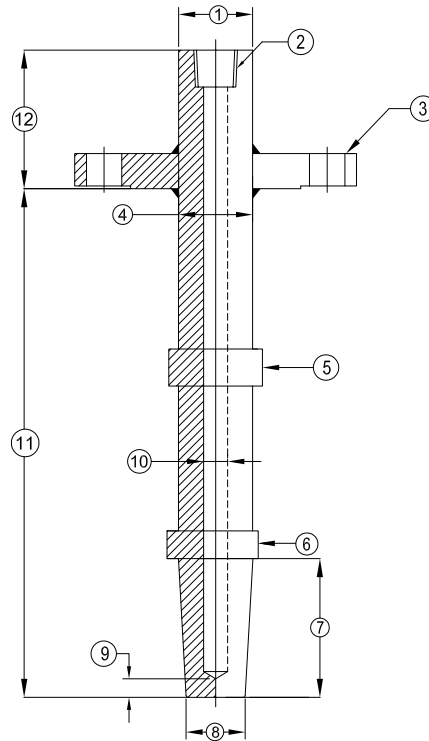

01. Finished head diameter
02. Instrument connection
03. Process connection
04. Major diameter
05. Velocity collar 2 (Optional)
06. Velocity collar 1
07. Reduced tip/taper length
08. Minor diameter
09. Tip thickness
10. Bore diameter
11. Unsupported (U) length
12. Extension length

ASME PTC 19.3TW-2010

The wake frequency calculation for thermowells gives a calculated proof of the strength with respect to static and dynamic stress in relation to the operating temperature and pressure. The standard is divided into dynamic and static calculation results. For gaseous media, a frequency ratio [r] of 0.8 is still valid however there are some cases where this does not apply. For liquid media, for most of the applications, frequency ratio [r] considers a 0.4.

In ITEC, experienced engineers calculate, optimize and issue the Wake Frequency Calculation as per the project requirements.

Resolution for WFC failure

There are mainly 4 ways to tackle the WFC failure. The resolutions are,

1. Shortening the insertion length
2. Increasing the root diameter
3. Increasing the tip diameter
4. Velocity collars

Although the use of Velocity collars has been out of scope of the new standard, many of the existing plants, experienced customers are preferred to use the Velocity collars to have a better sensing. The ideal Velocity collar location is considered as Stub length – 1". If the result is higher than 5" an additional Velocity collar can be added to lessen the stress effect on the thermowell. A circular or triangular or 4-point collar designs are used as a regular practice.

97/23/EC PED

The applicability of the 97/23/EC Pressure equipment directive in reference to thermowells is explained below in thermowells there is neither a fluid under pressure, nor is there any fluid transported within. Thermowells therefore are not "pressure-containing equipment" within the meaning of the Pressure equipment directive (see guideline 1/40).

Thermowells are components within pressure equipment in accordance with the PED. As such a component, it does not comply with the definition for pressure equipment in article 1, paragraph 2.1 of the PED and does not have to be marked with CE (see guideline 1/22).

LEVEL SWITCHES

SIDE / TOP MOUNTED

APPLICATIONS

- Reservoir tanks
- Ship manufacturers
- Hydro/Pneumatic tanks
- Sewage & water treatment
- Underground storage tanks
- Sterilization & coolant tanks

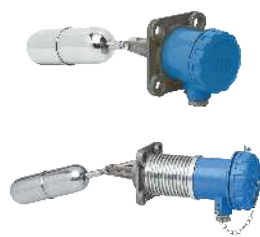

BASIC MODEL	L101	L102	L103	A401
SPECIAL FEATURES	Economical version Replaceable electricals	Economical version Easy installation	Field adjustable set point Easy installation All SS construction	Hydro tested
MOUNTING POSITION	Side Top	Top	Top	Top/Bottom Top/Side Side/Side Bottom/Side
TYPE	General purpose High temperature Adjustable trim	Flanged, with housing Threaded, with housing Flanged, with DIN connector	Flanged, with housing	Horizontal Top flanged Sealed Bottom flanged
SPECIFIC GRAVITY (Min.)	0.75	0.8	0.75	-
OPERATING TEMPERATURE (Max.)	-10...180°C Up to 350°C ¹	100°C	150°C	150°C
OPERATING PRESSURE (Max.)	18 bar	10 bar	10 bar	As per pipe schedule
PROCESS CONNECTION ³	92 PCD forged square flange 1" NPT (M) 2" #150 RF	92 PCD forged square flange 1" NPT (M) 2" #150 RF	2" #150 RF...2" #600 RF 3" #150 RF...3" #600 RF	As per requirement
SWITCH TYPES	1 SPDT 2 SPDT / DPDT (Optional)	1 SPST 1 SPDT (Optional)	1 SPST 1 SPDT (Optional)	-
SWITCH RATING	5A / 250 VAC Micro switch [®]	0.5A / 230 VAC Hermetically sealed reed switch	5A / 250 VAC Reed switch / Micro switch [®]	-
SWITCHING POINTS	1	1 or 2 or 3 or 4	1 or 2 or 3 or 4	-
INSERTION LENGTH	215 mm...375 mm (Max.)	200 mm...3,000 mm	200 mm...3,000 mm	200 mm...3,000 mm
ENCLOSURE PROTECTION ²	Weatherproof (IP 65) Flameproof Gr. IIA, IIB Ex-proof Gr IIC	Weatherproof (IP 65) Flameproof Gr. IIA, IIB Ex-proof Gr IIC	Weatherproof (IP 65) Flameproof Gr. IIA, IIB Ex-proof Gr IIC	-
ENCLOSURE MATERIAL ²	Die-cast aluminum AISI 304 SS AISI 316 SS	Die-cast aluminum AISI 304 SS AISI 316 SS	Die-cast aluminum AISI 304 SS AISI 316 SS	-
OPTIONAL EXTRAS	PTFE coating (up to 150°C) Matching flange External chamber	Matching flange External chamber	Still well in AISI 304 SS Still well in ASTM A105	MOC : ASTM A105 MOC : AISI 304 SS MOC : AISI 316 SS

- Notes**
1. With aluminum cooling tower
 2. Optional, charges extra, contact factory for details.
 3. Other connections & sizes are available, charges extra, contact factory for details.

LEVEL INDICATORS

SIDE / TOP MOUNTED

APPLICATIONS

- Petrochemicals
- Large storage tanks
- Oil & petroleum tanks
- Pressurized clear liquids
- Pharmaceutical industries
- Power & Process industries
- Chemical & fertilizer plants
- Custody transfer, reservoirs & storage tanks



BASIC MODEL	L201	L202/L203	L204	L205
SPECIAL FEATURES	Magnetic transmission Clear indication through rollers Switch & transmitter mountable Long life	Reflex / Transparent type gauge glass High pressure version	Economical version Tubular glass tube	Economical version Adjustable brackets for mounting Easy transportation & installation All non-hazardous & non-pressurized tanks
TYPE	Side/Side Top	Side/Side	Side/Side	Top
SPECIFIC GRAVITY (Min.)	0.75	-	-	0.75
OPERATING TEMPERATURE (Max.)	-20...120°C -20...400°C ²	120°C Up to 240°C & 400°C ²	120°C	100°C
OPERATING PRESSURE (Max.)	Up to 10 bar Up to 25 bar & 50 bar ²	Up to 20 bar Up to 35 bar & 65 bar ²	Up to 10 bar	Up to 6 bar
PROCESS CONNECTION ³	1/2" NPT (M)...1" NPT (M) 1/2" BSP (M)...1" BSP (M) 1/2"...5" flange to ANSI B16.5 Rating 150#...2500#	1/2" NPT (M)...1" NPT (M) 1/2" BSP (M)...1" BSP (M) 1/2"...5" flange to ANSI B16.5 Rating 150#...2500#	1/2" NPT (M)...1" NPT (M) 1/2" BSP (M)...1" BSP (M) 1/2"...5" flange to ANSI B16.5 Rating 150#...2500#	1/2"...5" flange to ANSI B16.5 Rating 150#...2500#
INDICATOR	Rolling flappers (Blue/White or Red/White)	Gauge glass	Glass, tubular	CS cradle pointer on aluminum scale
WETTED PARTS ²	AISI 316 SSS AISI 316L SS	Carbon steel AISI 304 SS AISI 316 SS	Carbon steel AISI 304 SS AISI 316 SS	AISI 316 SS AISI 316L SS
CENTRE TO CENTRE DISTANCE	200 mm...6000 mm ¹	350 mm...4000 mm	350 mm...1500 mm	1500 mm...20,000 mm
CALIBRATED SCALE	Aluminum AISI 304 SS ²	Aluminum AISI 304 SS ²	Aluminum AISI 304 SS ²	Aluminum, powder coated
OPTIONAL EXTRAS	Switches, 1 SPDT (5A/250VAC) (1 / 2 / 3 / 4 switching points) Transmitter (4...20 mA) Still well in AISI 316 SS Still well in AISI 316L SS Still well in AISI 304 SS Still well in ASTM A105	Anti-frost protection ⁴ Illuminator with diffuser ⁴ Ball valve - Bolted bonnet type	Ball valve - Bolted bonnet type	Anchor plate

- Notes**
1. Two piece construction >3500 mm.
 2. Optional, charges extra, contact factory for details.
 3. Other connections & sizes are available, charges extra, contact factory for details.
 4. Applicable for L203 only.

LEVEL SWITCHES

SIDE / TOP MOUNTED

APPLICATIONS

- Ship manufacturers
- Corrosive applications
- Acid or Alkaline tanks
- Alarm controls for tanks
- Water & sewage tanks
- Chemical or solvent tanks
- Coolant, processing & sterilizing tanks



BASIC MODEL	L301	L302	L303	L304
SPECIAL FEATURES	Compact design Easy installation	Compact design Economical version Wetted parts polypropelene	Economical version Easy installation	Economical version Easy installation
MOUNTING POSITION	Side / Top	Side / Top	Top	Top
TYPE	Side mounted, side switching Top mounted, top switching Side mounted, top switching	-	-	-
SPECIFIC GRAVITY (Min.)	0.75	0.75	0.8	0.8
OPERATING TEMPERATURE (Max.)	100°C	-20...80°C	60°C	60°C
OPERATING PRESSURE (Max.)	10 bar	4 bar	4 bar	4 bar
PROCESS CONNECTION ²	1/4" NPT (M)...1/2" NPT (M) 1/4" BSP (M)...1/2" BSP (M)	1/2" NPT (M) M16 x 1 mm 1/8" PF	3" #150 RF 3" #300 RF 4" #150 RF / 4" #300 RF	-
SWITCH TYPES	1 SPST 1 SPDT ¹	1 SPST Reversible Switching Action 1	1 SPDT	1 SPDT
SWITCH RATING	0.5A / 230 VAC Hermetically sealed reed switch	0.5A, 240 VAC / 200 VDC Reed switch	16A / 250 VAC Reed switch	16A / 250 VAC Reed switch
SWITCHING POINTS	1	1	1 or 2 or 3 or 4	1
INSERTION LENGTH	-	-	200 mm...9,000 mm	10,000 mm
ENCLOSURE PROTECTION ¹	-	-	Weatherproof (IP 65) Flameproof Gr. IIA, IIB Ex-proof Gr IIC	-
ENCLOSURE MATERIAL ¹	-	-	Die-cast aluminum AISI 304 SS AISI 316 SS	-
OPTIONAL EXTRAS	DIN connectors (side/side)	-	Matching flange	-

Notes 1. Optional, charges extra, contact factory for details.
2. Other connections & sizes are available, charges extra, contact factory for details.

APPLICATIONS

- Railways & turbines
- Fire fighting systems
- Lubrication industries
- Refrigeration & HVAC
- Water treatment plants
- Pumps, compressors & boilers
- Hydraulic & pneumatic equipments
- Textile machine builders
- Automobiles & Earthmovers

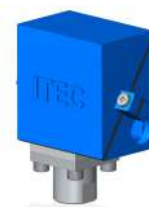
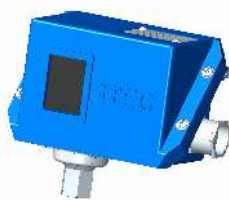

BASIC MODEL	S101	S102	S103	S104
SPECIAL FEATURES	Compact & Economical Field adjustable set point Auto Reset CE complied	Cast Aluminum enclosure Adjustable differential Field adjustable set point with internal or external Auto Reset (internal)	OEM applications Fixed differential Field adjustable set point with external	OEM applications Fixed differential Field adjustable set point with internal
SENSING ELEMENT ²	Bellows, Phosphor bronze Stainless steel	Bellows, Phosphor bronze Stainless steel	Diaphragm, NBR Teflon	Diaphragm, 316 SS Teflon
RANGE ¹	-0.5...0...30 bar	-0.5...0...30 bar	1...250 bar	1...250 bar
REPRODUCIBILITY	CL 2.0	CL 2.0	CL 2.0	CL 2.0
SWITCH TYPE	Micro switch 1 SPDT	Micro switch 1 SPDT	Micro switch 1 SPST	Micro switch 1 SPDT
SWITCH RATING ⁴	15A / 220 VAC	15A / 220 VAC	5A / 220 VAC	5A / 220 VAC
ENCLOSURE MATERIAL ²	Steel (plated) Plastic cover	Die-cast Aluminum	Stainless steel AISI 316 SS (Optional)	Die-cast Aluminum
ENCLOSURE PROTECTION	IP 32	IP 67	-	IP 67
PROCESS CONNECTION ³	1/4" BSP (F)	1/4" BSP (F)	1/4" BSP (M)	1/4" BSP (F)
APPROVAL	CE complied	-	-	-
OPTIONAL EXTRAS	Mounting bracket with screw	Mounting bracket with screw	DIN connector	SS tag plate

Refer pages 10...13 for Diaphragm seal, 16...18 for Accessories, 34...37 for Valves & Manifolds.

- Notes**
1. Refer range table for the exact ranges.
 2. Optional, charges extra, contact factory for details.
 3. Other connections & sizes are available, charges extra, contact factory for details.
 4. Refer switch table for the switch ratings available.

PRESSURE / TEMPERATURE SWITCHES

WEATHERPROOF

APPLICATIONS

- Filtration plants
- Food & beverages
- Railways & turbines
- Fertilizers & cement
- Paper & pulp industries
- Chemical & petro-chemical



BASIC MODEL	S201	S202	S203	T704
SPECIAL FEATURES	Enclosure Protection : IP 67 Fix/Adjustable differential Field adjustable set point with internal/external locking Various types of switch Indicating scale	Differential pressure switch Enclosure Protection : IP 67 Fix/Adjustable differential Field adjustable set point with internal/external locking Various types of switch Indicating scale	Enclosure Protection : IP 67 Fix/Adjustable differential Field adjustable set point with internal/external locking Various types of switch Indicating scale	Inert gas filled expansion Various type of Microswitches Weatherproof / Ex-proof versions
SENSING ELEMENT ²	Diaphragm, 316 SS Monel / Hastelloy C / Teflon	Diaphragm, 316 SS Monel / Hastelloy C / Teflon	Piston, 316 SS	Sensor bulb, 316 SS
WETTED PARTS ² (Bottom chamber)	316 SS 316L SS / Monel / Teflon Hastelloy C	316 SS 316L SS / Monel / Teflon Hastelloy C	316 SS	316 SS
RANGE ¹	-20mbar...160 bar	5 mbar...25 bar	10...400 bar	5...400°C ³
REPRODUCIBILITY	CL 1.0 CL 0.5 ²	CL 1.0 CL 0.5 ²	CL 2.0	CL 3.0
SWITCH TYPE	Micro switch 1 SPDT / 2 SPDT / DPDT	Micro switch 1 SPDT / 2 SPDT / DPDT	Micro switch 1 SPDT / 2 SPDT / DPDT	Micro switch 1 SPDT / 2 SPDT / DPDT
SWITCH RATING ⁴	General : 15A / 250 VAC or 2A / 24 VDC	General : 15A / 250 VAC or 2A / 24 VDC	General : 15A / 250 VAC or 2A / 24 VDC	General : 15A / 250 VAC or 1A / 24 VDC
ENCLOSURE MATERIAL	Die-cast Aluminum	Die-cast Aluminum	Die-cast Aluminum	Die-cast Aluminum
ENCLOSURE PROTECTION	IP 67	IP 67	IP 67	IP 67
PROCESS CONNECTION ⁶	1/4" BSP (F)	1/4" BSP (F) x 2 Nos.	1/4" BSP (F)	3/8" BSP (M) ⁵
REFERENCE STANDARD	BS 6134	BS 6134	BS 6134	-
APPROVAL	Type test to BS 6134	Type test to BS 6134	Type test to BS 6134	-
OPTIONAL EXTRAS	Plug in / DIN connector Wall mounting bracket 2" pipe mounting bracket NACE MR0175	SS Cable gland, double compression, weatherproof Brass Cable gland, double compression, weatherproof Plug in / DIN connector Wall mounting bracket 2" pipe mounting bracket NACE MR0175 with Seal	Plug in / DIN connector Wall mounting bracket 2" pipe mounting bracket NACE MR0175 with Seal	Wall mounting bracket 2" pipe mounting bracket

Refer pages 10...13 for Diaphragm seal, 16...18 for Accessories, 34...37 for Valves & Manifolds.

- Notes**
1. Refer range table for the exact ranges.
 2. Optional, charges extra, contact factory for details.
 3. Other connections & sizes are available, charges extra, contact factory for details.
 4. Refer switch table for the switch ratings available.

PRESSURE / TEMPERATURE SWITCHES

FLAMEPROOF / EXPLOSIONPROOF

APPLICATIONS

- Furnaces & Refineries
- Paper & pulp industries
- Fertilizers & cement Industries
- Marine, Glass & Paint industries
- Oil & Gas, Steel & Power Industries
- Chemical & petro-chemical industries



BASIC MODEL	S301	S302	S303	T705
SPECIAL FEATURES	Flame-proof version (standard) Ex-proof version (optional) Fix / Adjustable differential Field adjustable set point with internal / external Various types of Micro switch	Differential pressure switch Flameproof / Ex-proof versions Fix/Adjustable differential Field adjustable set point with internal / external Various types of Micro switch	Flame-proof version (standard) Ex-proof version (optional) Fix/Adjustable differential Field adjustable set point with internal / external Various types of Micro switch	Inert gas filled expansion Various type of Microswitches Weatherproof / Ex-proof versions
SENSING ELEMENT ²	Diaphragm, 316 SS Monel / Hastelloy C / Teflon	Diaphragm, 316 SS Monel / Hastelloy C / Teflon	Piston, 316 SS	Sensor bulb, 316 SS
WETTED PARTS ² (Bottom chamber)	316 SS 316L SS / Monel / Teflon Hastelloy C	316 SS 316L SS / Monel / Teflon Hastelloy C	316 SS	316 SS
RANGE ¹	-20mbar...160 bar	5 mbar...25 bar	10...400 bar	5...400°C ³
REPRODUCIBILITY	CL 1.0 CL 0.5 ²	CL 1.0 CL 0.5 ²	CL 2.0	CL 3.0
SWITCH TYPE	Micro switch 1 SPDT / 2 SPDT / DPDT	Micro switch 1 SPDT / 2 SPDT / DPDT	Micro switch 1 SPDT / 2 SPDT / DPDT	Micro switch 1 SPDT / 2 SPDT / DPDT
SWITCH RATING ⁴	General : 15A / 250 VAC or 2A / 24 VDC	General : 15A / 250 VAC or 2A / 24 VDC	General : 15A / 250 VAC or 2A / 24 VDC	General : 15A / 250 VAC or 1A / 24 VDC
ENCLOSURE MATERIAL	Die-cast Aluminum	Die-cast Aluminum	Die-cast Aluminum	Die-cast Aluminum
ENCLOSURE PROTECTION	IP 65 Flameproof Gr. IIA, IIB Ex-proof Gr IIC ²	IP 65 Flameproof Gr. IIA, IIB Ex-proof Gr IIC ²	IP 65 Flameproof Gr. IIA, IIB Ex-proof Gr IIC ²	IP 65 Flameproof Gr. IIA, IIB Ex-proof Gr IIC ²
PROCESS CONNECTION ³	1/4" BSP (F)	1/4" BSP (F) x 2 No.s	1/4" BSP (F)	3/8" BSP (M) ⁵
REFERENCE STANDARD	EN 60079-1	EN 60079-1	EN 60079-1	EN 60079-1
APPROVAL	Type test to BS 6134	Type test to BS 6134	Type test to BS 6134	-
OPTIONAL EXTRAS	Wall mounting bracket 2" pipe mounting bracket NACE MR0175	SS Cable gland, double compression, flameproof Wall mounting bracket 2" pipe mounting bracket NACE MR0175 with Seal	Wall mounting bracket 2" pipe mounting bracket NACE MR0175 with Seal	Wall mounting bracket 2" pipe mounting bracket

- Notes**
1. Refer range table for the exact ranges.
 2. Optional, charges extra, contact factory for details.
 3. Other connections & sizes are available, charges extra, contact factory for details.
 4. Refer switch table for the switch ratings available.

MANIFOLDS

2-VALVE / 3-VALVE / 4-VALVE / 5-VALVE

APPLICATIONS

- Liquid & gas services
- High pressure line shut off
- Isolation & drain / vent services
- For mounting pressure instruments
- Isolation & venting of DP type transmitters



BASIC MODEL	M102	M103	M104	M105
SPECIAL FEATURES	1 Isolate & 1 Vent valves	2 Isolate & 1 Equalize valves with vent plugs	2 Isolate, 1 Equalize & 1 Vent valves (DIN 19213 design)	2 Isolate, 1 Equalize & 2 Vent valves with drain plugs
MOUNTING PATTERN	Pipe to Pipe Pipe to Flange (Co-planar)	Pipe to Pipe Pipe to Flange (54 mm CTC) Pipe to Flange (Co-planar) Flange to Flange	Pipe to Flange (54 mm)	Pipe to Pipe Pipe to Flange (54 mm CTC) Pipe to Flange (Co-planar) Flange to Flange
NEEDLE TYPE	Hard seated	Hard seated	Hard seated	Hard seated
MATERIAL OF CONSTRUCTION ¹	AISI 316 SS AISI 304 SS / AISI 316L SS Monel / Hastelloy C / Inconel	AISI 316 SS AISI 304 SS / AISI 316L SS Monel / Hastelloy C / Inconel	AISI 316 SS AISI 304 SS / AISI 316L SS Monel / Hastelloy C / Inconel	AISI 316 SS AISI 304 SS / AISI 316L SS Monel / Hastelloy C / Inconel
MOUNTING	Direct Remote	Direct Remote	Direct	Direct Remote
TEMPERATURE RATING	240°C	240°C	240°C	240°C
PRESSURE RATING	6000 psi	6000 psi	6000 psi	6000 psi
CONNECTION SIZES	1/4" ... 1/2"	1/4" ... 1/2"	1/2"	1/4" ... 1/2"
THREAD TYPES ²	NPT (ANSI B 1.20.1) BSP (BS 2279, ISO 228/1) BSPT (BS 21, ISO 7/1)	NPT (ANSI B 1.20.1) BSP (BS 2279, ISO 228/1) BSPT (BS 21, ISO 7/1)	NPT (ANSI B 1.20.1)	NPT (ANSI B 1.20.1) BSP (BS 2279, ISO 228/1) BSPT (BS 21, ISO 7/1)
CONNECTIONS (Instrument x Process)	Female x Female Male x Female Female x Male Socket weld Female x Co-planar	Female x Female Socket weld Male x Female (swivel nut) Female x Female (swivel nut) Female x Flange (54 mm CTC) Female x Co-planar	Female x Flange (54 mm)	Female x Female Socket weld Male x Female (swivel nut) Female x Female (swivel nut) Female x Flange (54 mm CTC) Female x Co-planar
STEM PACKING	PTFE Grafoil	PTFE Grafoil	PTFE Grafoil	PTFE Grafoil
OPTIONAL EXTRAS	NACE MR0175 / MR0103 Oxygen service Mounting brackets	NACE MR0175 / MR0103 Oxygen service Mounting brackets	NACE MR0175 / MR0103 Oxygen service Anti-tamper valve & key	NACE MR0175 / MR0103 Oxygen service Mounting brackets

Refer page 43 for Valve Accessories.

- Notes**
1. Optional others, charges extra, contact factory for details.
 2. Other connections & sizes are available, charges extra, contact factory for details.

APPLICATIONS

- Oil & gas applications
- Isolation & drain / vent services
- Distribution applications in skids
- For mounting pressure instruments
- For Instruments with flow volume displacement at full range
- For steam metering lines with liquids flowing above 150°C...450°C



BASIC MODEL	M201	M202	M202	M202
SPECIAL FEATURES	Selection of 4, 6, 8, 10, 12, 14, 16 & 18 outlet options with individual isolation valves	Leak path reduction in conventional instrument mounting Reduced cost & weight	Leak path reduction in conventional instrument mounting Reduced cost & weight	Leak path reduction in conventional instrument mounting Reduced cost & weight
MOUNTING PATTERN	Pipe to Pipe	Single block & bleed	Single block & bleed + Siphon	Double block & bleed
NEEDLE TYPE	Hard seated	Hard seated	Hard seated	Hard seated
MATERIAL OF CONSTRUCTION ¹	AISI 316 SS AISI 316L SS AISI 304 SS ASTM A105	AISI 316 SS AISI 304 SS / AISI 316L SS Monel / Hastelloy C / Inconel	AISI 316 SS AISI 304 SS / AISI 316L SS Monel / Hastelloy C / Inconel	AISI 316 SS AISI 304 SS / AISI 316L SS Monel / Hastelloy C / Inconel
MOUNTING / PIPE SIZES	Direct	Direct	Direct	Direct
TEMPERATURE RATING	240°C	240°C	240°C	240°C
PRESSURE RATING	6000 psi	6000 psi	6000 psi	6000 psi
CONNECTION SIZES	1/4"...1"	1/2" #150 RF...4" #2500 RF	1/2" #150 RF...4" #2500 RF	1/2" #150 RF...4" #2500 RF
CONNECTIONS (Instrument x Process) Or PIPE SCHEDULE (For A205)	Female x Female	1/2" NPT (F) x Flange	1/2" NPT (F) x Flange	1/2" NPT (F) x Flange
THREAD TYPES	NPT (ANSI B 1.20.1)	NPT (ANSI B 1.20.1)	NPT (ANSI B 1.20.1)	NPT (ANSI B 1.20.1)
STEM PACKING	PTFE Grafoil	PTFE Grafoil	PTFE Grafoil	PTFE Grafoil
OPTIONAL EXTRAS	NACE MR0175 / MR0103 Mounting brackets	NACE MR0175 / MR0103 Oxygen service Anti-tamper valve & key	NACE MR0175 / MR0103 Oxygen service Anti-tamper valve & key	NACE MR0175 / MR0103 Oxygen service Anti-tamper valve & key

Refer page 43 for Valve Accessories.

NEEDLE VALVES

ISOLATION / BLOCK & BLEED / MULTI-PORT

APPLICATIONS

- Gas sampling
- Instrument isolation
- Control loops / panels
- Air Header assemblies
- Multiple instrument mounting
- Instrument isolation with vent and calibration connections



BASIC MODEL	V101	V102	V103	V104 / V105
SPECIAL FEATURES	1 Inlet & 1 Outlet Back seating to prevent stem blow-out Isolation valve	1 Inlet & 1 Outlet with vent plugs Back seating to prevent stem blow-out Block & bleed valve	1 Inlet & 3 Outlet Back seating to prevent stem blow-out Multi-port valve	1 Inlet & 1 Outlet Back seating to prevent stem blow-out for V104 Miniature valve
TYPE	Hard seated, needle Soft seated, needle Raising plug design, needle Standard needle pattern	Hard seated, needle	Hard seated, needle Soft seated, needle	Low torque seated, needle
MATERIAL OF CONSTRUCTION ¹	AISI 316 SS AISI 304 SS / AISI 316L SS Monel / Hastelloy C	AISI 316 SS AISI 304 SS / AISI 316L SS Monel / Hastelloy C	AISI 316 SS AISI 304 SS / AISI 316L SS Monel / Hastelloy C	AISI 316 SS AISI 304 SS
MOUNTING	In-line / direct Angular	In-line / direct	In-line / direct	In-line / direct
TEMPERATURE RATING	240°C 100°C (soft seated)	240°C	240°C 100°C (soft seated)	240°C (V104) 120°C (V105)
PRESSURE RATING	6000 psi 10,000 psi & 20,000 psi ¹	6000 psi	6000 psi	3000 psi (V104) 1500 psi (V105)
PROCESS CONNECTION	1/8" ... 1" 1 1/2" & 2"	1/4" ... 3/4"	1/4" ... 3/4"	1/4" ... 1/2"
THREAD TYPES ²	NPT (ANSI B 1.20.1) BSP (BS 2279, ISO 228/1) BSPT (BS 21, ISO 7/1)	NPT (ANSI B 1.20.1) BSP (BS 2279, ISO 228/1) BSPT (BS 21, ISO 7/1)	NPT (ANSI B 1.20.1) BSP (BS 2279, ISO 228/1) BSPT (BS 21, ISO 7/1)	NPT (ANSI B 1.20.1) BSP (BS 2279, ISO 228/1) BSPT (BS 21, ISO 7/1)
CONNECTIONS (Instrument x Process)	Female x Female Male x Female Male x Male Socket weld	Female x Female Male x Female Socket weld	Female x Female Male x Female	Female x Female Male x Female Male x Male
STEM PACKING	PTFE Grafoil	PTFE Grafoil	PTFE Grafoil	PTFE
OPTIONAL EXTRAS	NACE MR0175 / MR0103 Oxygen service	NACE MR0175 / MR0103 Oxygen service Vent plug in 1/4" NPT	NACE MR0175 / MR0103 Bleed with T handle Bleeder	Oxygen service

Refer page 43 for Valve Accessories.

- Notes**
1. Optional others, charges extra, contact factory for details.
 2. Other connections & sizes are available, charges extra, contact factory for details.

NEEDLE VALVES

BALL / NON-RETURN / TUBE-END

APPLICATIONS

- Media throttling
- Instrument isolation
- Liquid & gas services
- Protection of instruments from sudden pressure hikes



BASIC MODEL	V201	V202	V203	V204 / V205
SPECIAL FEATURES	Economical version Leak point reduction	Adjustable cracking points Variety of end connections	Back seating to prevent stem blow-out	Various mounting types Exotic material optional
TYPE	One piece ball stem	Spring	Hard seated, needle Soft seated, needle Raising plug designs, needle	Type 1* Optional : Type 2 & Type 3 *(Standard & applicable for A204)
MATERIAL OF CONSTRUCTION ¹	AISI 316 SS AISI 304 SS / AISI 316L SS	AISI 316 SS	AISI 316 SS AISI 304 SS / AISI 316L SS	AISI 316 SS AISI 304 SS / AISI 316L SS
MOUNTING	In-line / direct	In-line / direct	In-line / direct	4"/100 mm 2" / 50 mm & 3" / 80 mm 450°C (Max)
TEMPERATURE RATING	120°C	240°C	240°C 100°C (soft seated)	6000 psi
PRESSURE RATING	1000 psi	6000 psi	6000 psi	1/4", 1/2", 3/4" & 1" (A205) 1/4" & 1/2" (A204)
CONNECTION SIZES	1/4" ... 1/2"	1/4" ... 2"	6 mm ... 12 mm 1/4" ... 1/2"	Sch 40 Sch 80 & Sch 160
THREAD TYPES ²	NPT (ANSI B 1.20.1) BSP (BS 2279, ISO 228/1)	NPT (ANSI B 1.20.1) BSP (BS 2279, ISO 228/1)	NPT (ANSI B 1.20.1) BSP (BS 2279, ISO 228/1)	NPT (ANSI B 1.20.1) BSP (BS 2279, ISO 228/1) BSPT (BS 21, ISO 7/1)
CONNECTIONS (Instrument x Process)	Female x Female	Female x Female Tube x Tube	Tube x Tube Tube x Male Tube x Female Male x Tube Female x Tube	
STEM PACKING	PTFE Grafoil	PTFE	PTFE Grafoil	Grafoil
OPTIONAL EXTRAS	Oxygen service	Oxygen service	NACE MR0175 / MR0103 Oxygen service	NACE MR0175 / MR0103 Bleed with T handle Bleeder

Refer page 43 for Valve Accessories.

- Notes**
1. Optional others, charges extra, contact factory for details.
 2. Other connections & sizes are available, charges extra, contact factory for details.

APPLICATIONS

- Mounting brackets & bolts
- Gaskets for valve / gauge mounting
- Drain & bleed accessories for valves



BASIC MODEL	A501/A502	A506	A507	A510
MATERIAL OF CONSTRUCTION	AISI 304 SS AISI 316 SS	Steel, nickel plated AISI 304 SS AISI 316 SS	PTFE Grafoil	AISI 304 SS
TYPE	Type - 1 Type - 2 Type - 3	7/16" UNF x 45 mm length 7/16" UNF x 25 mm length	-	Allan key style
OTHER DETAILS	-	-	PTFE = 200°C Grafoil = 430°C	T-bar handle for ease of operation Suitable bonnet assembly for valves



BASIC MODEL	A503	A504	A505	A509
MATERIAL OF CONSTRUCTION	AISI 316 SS Optional : AISI 316L SS, Monel (Other materials, contact factory)	AISI 316 SS Optional : AISI 316L SS, Monel (Other materials, contact factory)	AISI 316 SS Optional : AISI 316L SS, Monel (Other materials, contact factory)	AISI 316 SS Optional : AISI 316L SS, Monel (Other materials, contact factory)
CONNECTION SIZES	1/8", 1/4" & 1/2"	1/2"	1/4" & 1/2"	M6 x 1.5 mm
THREAD TYPES	NPT (ANSI B 1.20.1) BSP (BS 2279, ISO 228/1)	NPT (ANSI B 1.20.1) BSP (BS 2279, ISO 228/1)	NPT (ANSI B 1.20.1) BSP (BS 2279, ISO 228/1)	Metric thread

APPLICATIONS

- Oil & Gas industries
- Petro-chemical / Chemical processing
- Shipbuilding & Heavy industrial industries
- Power generation, Pulp & paper industries
- Cryogenic & semiconductor industries
- Research laboratories

FEATURES

- Easy & low torque engagement
- Leak free assembly & re-assembly
- Various patterns & connections
- Wide variety of materials



BASIC MODEL	F101	F201	F301	F401/ 402
TUBE SIZE ¹	1/8"...1" (Imperial) or 6mm...25 mm (Metric)	1/8"...1" (Imperial) or 6mm...25 mm (Metric)	1/8"...1" (Imperial) or 6mm...25 mm (Metric)	1/4"...1" (Imperial) or 6mm...16 mm (Metric)
MATERIAL OF CONSTRUCTION ²	AISI 316 SS AISI 304 SS / AISI 316L SS Monel / Brass	AISI 316 SS AISI 304 SS / AISI 316L SS Monel / Brass	AISI 316 SS AISI 304 SS / AISI 316L SS Monel / Brass	AISI 316 SS AISI 304 SS / AISI 316L SS Monel / Brass
THREAD / TUBE SIZE ¹	1/8"...1" (Imperial) or 6mm...25 mm (Metric)	1/8"...1" NPT (M) BSP, M20x1.5 mm	1/8"...1" NPT (M) BSP, M20x1.5 mm	1/4"...1" pipe diameter (Socket/Butt weld)



BASIC MODEL	F103	F203	F303	F102
TUBE SIZE ¹	1/8"...1" (Imperial) or 6mm...25 mm (Metric)	1/8"...1" (Imperial) or 6mm & 12 mm (Metric)	1/8"...1/2" (Imperial) or 6mm & 12 mm (Metric)	1/4"...1" (Imperial) or 8mm...25 mm (Metric)
MATERIAL OF CONSTRUCTION ²	AISI 316 SS AISI 304 SS / AISI 316L SS Monel / Brass	AISI 316 SS AISI 304 SS / AISI 316L SS Monel / Brass	AISI 316 SS AISI 304 SS / AISI 316L SS Monel / Brass	AISI 316 SS AISI 304 SS / AISI 316L SS Monel / Brass
THREAD / TUBE SIZE ¹	1/8"...1" (Imperial) or 6mm...25 mm (Metric)	1/8"...1" NPT (M) BSP, M20x1.5 mm	1/8"...1/2" NPT (M) BSP, M20x1.5 mm	1/8"...3/4" (Imperial) or 6mm...20 mm (Metric)

Notes 1. Other connections & sizes are available, charges extra, contact factory for details.
2. Other materials, charges extra, contact factory for details.

APPLICATIONS

- Oil & Gas industries
- Petro-chemical / Chemical processing
- Shipbuilding & Heavy industrial industries
- Power generation, Pulp & paper industries
- Cryogenic & semiconductor industries
- Research laboratories

FEATURES

- Easy & low torque engagement
- Leak free assembly & re-assembly
- Various patterns & connections
- Wide variety of materials



BASIC MODEL	F104	F204	F304	F404
TUBE SIZE ¹	1/8" ... 1" (Imperial) or 6mm ... 25 mm (Metric)	1/8" ... 1" (Imperial) or 6mm ... 25 mm (Metric)	1/8" ... 1" (Imperial) or 6mm ... 16 mm (Metric)	1/4" ... 1" (Imperial)
MATERIAL OF CONSTRUCTION ²	AISI 316 SS AISI 304 SS / AISI 316L SS Monel / Brass	AISI 316 SS AISI 304 SS / AISI 316L SS Monel / Brass	AISI 316 SS AISI 304 SS / AISI 316L SS Monel / Brass	AISI 316 SS AISI 304 SS / AISI 316L SS Monel / Brass
THREAD / TUBE SIZE ¹	1/8" ... 1" (Imperial) or 6mm ... 25 mm (Metric)	1/8" ... 1" NPT (M) BSP, M20x1.5 mm	1/8" ... 1" NPT (F) BSP, M20x1.5 mm	1/4" ... 1" pipe diameter



BASIC MODEL	F105/F106	F205	F305	F614
TUBE SIZE ¹	1/8" ... 1" (Imperial) or 6mm ... 25 mm (Metric)	1/8" ... 3/4" (Imperial) or 6mm ... 16 mm (Metric)	1/8" ... 1" (Imperial) or 6mm ... 16 mm (Metric)	1/8" ... 1" (Imperial) or 6mm ... 25 mm (Metric)
MATERIAL OF CONSTRUCTION ²	AISI 316 SS AISI 304 SS / AISI 316L SS Monel / Brass	AISI 316 SS AISI 304 SS / AISI 316L SS Monel / Brass	AISI 316 SS AISI 304 SS / AISI 316L SS Monel / Brass	AISI 316 SS AISI 304 SS / AISI 316L SS Monel / Brass
THREAD / TUBE SIZE ¹	1/8" ... 1" (Imperial) or 6mm ... 25 mm (Metric)	1/8" ... 3/4" NPT (M) BSP, M20x1.5 mm	1/8" ... 1" NPT (M) BSP, M20x1.5 mm	1/8" ... 1" (Imperial) or 6mm ... 25 mm (Metric)

Notes 1. Other connections & sizes are available, charges extra, contact factory for details.
2. Other materials, charges extra, contact factory for details.

CUSTOMER REFERENCE



Exclusive Agent and Distributor



ITEC srl.
Via Cesare Battisti 114/b
28045 INVORIO (NO) ITALY
E-mail: info@itec.it



Fartak Tajhiz Ista
No.77, Kimia Building, East
Artesh Blvd, Tehran - Iran
Tel.: +982122468397-98
Fax: +982122468442
E-mail: info@fatiglobal.com